

Minolta MINOLTA MEANS BETTER PICTURES

H7SII 810E-B7 P10

Printed in Japan

MINOLTA HI-MATIC 7SII

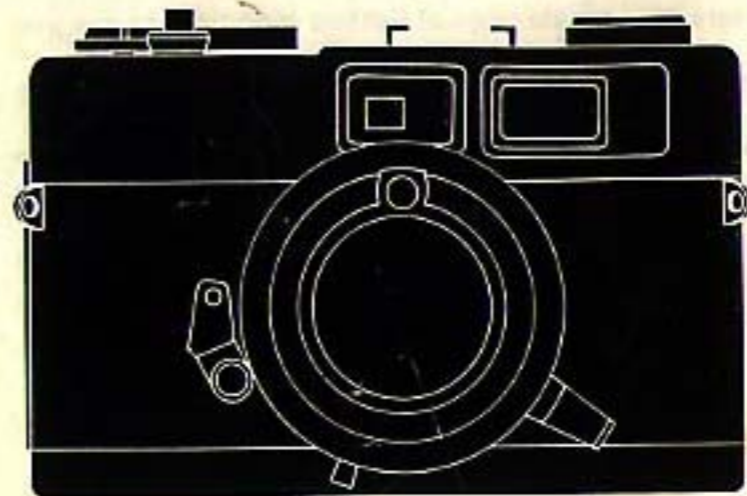

OWNER'S MANUAL

E

Your Minolta Hi-matic 7s II is a light, compact, easy-handling camera that features both automatic and manual operation and a coupled, superimposed-image rangefinder.

In automatic position all you do is select a shutter speed, focus and shoot. The camera's CdS EE system will adjust the aperture over a wide range of lighting conditions to give you proper exposure.

Special photographic techniques, such as deliberate over- or underexposure may be achieved in manual operation.

The information-center viewfinder shows the aperture the camera has selected in automatic position and warns you when it is necessary to change shutter speeds to prevent over- or underexposure.

Please take a few minutes to read this instruction manual through carefully for best results and longest service life from your new Hi-matic 7s II.

CONTENTS

NAMES OF PARTS	2	OPTIONAL ACCESSORIES	21
BEFORE TAKING PICTURES	4	Auto Electroflash 25	21
Battery	4	Electroflash 20	21
Installing	4	Minolta Lens Shade	22
Checking battery	5	Minolta Filters	23
Loading and advancing film	6	DEPTH-OF-FIELD CHART	23
Setting film speed	9	SPECIFICATIONS	24
HOW TO TAKE PICTURES	10	CARE AND STORAGE	25
Focusing	10		
Framing	11		
Automatic exposure	12		
Over/underexposure warning	13		
Manual exposures	14		
"B" (bulb) setting	14		
Depth-of-field	15		
Holding the camera	16		
Using self-timer	17		
Flash pictures	18		
Rewinding and unloading film	20		

NAMES OF PARTS

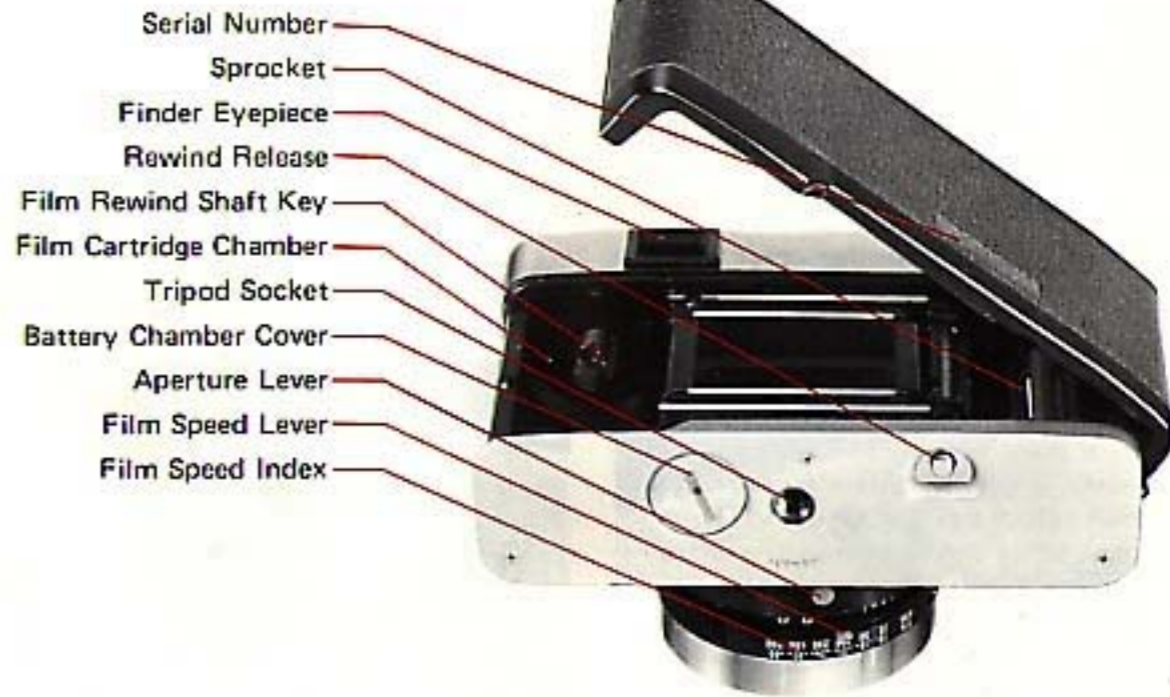

BEFORE TAKING PICTURES

4 Battery

The automatic exposure system of this camera is powered by a 1.3 volt mercury battery. Use Eveready EPX-675, or equivalent.

Installing

1. Remove battery chamber cover by using a coin or similar object to turn it counterclockwise.
2. Insert battery with plus (+) side out and screw cover back on.



Checking battery

Set the aperture ring to "AUTO" (see page 12) and frame a bright subject in the viewfinder. If the exposure-indicating needle remains in the red area at the bottom of the scale, battery is improperly installed or unserviceable.



Battery life

A battery should last about one year under usual conditions. It is recommended that battery be replaced with a new one every year and that a spare be carried on trips with the camera.

CAUTION:

- Do not use Mallory RM-675 or RM-675 GH batteries which have a similar shape as the Eveready EPX-675 as they will cause underexposure.
- Do not touch battery terminals with fingers. Before inserting battery, clean terminals with a clean dry cloth. Remove battery if camera is not to be used for one month or longer.

Loading and advancing film

1. Pull out on the back release knob and open the back cover.

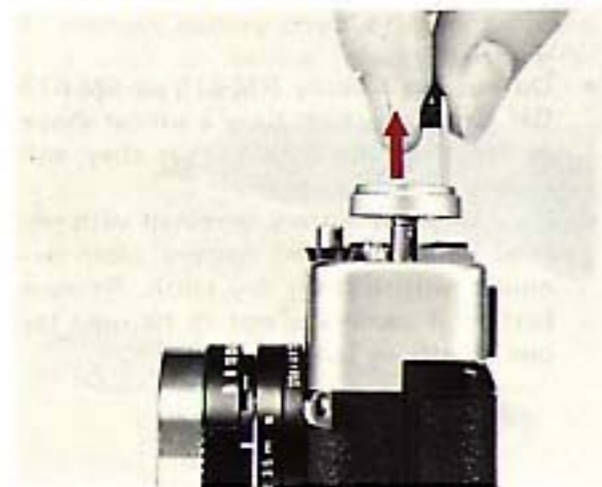

2. Insert film-cartridge into chamber as shown and push the knob all the way in, rotating it slightly if necessary.

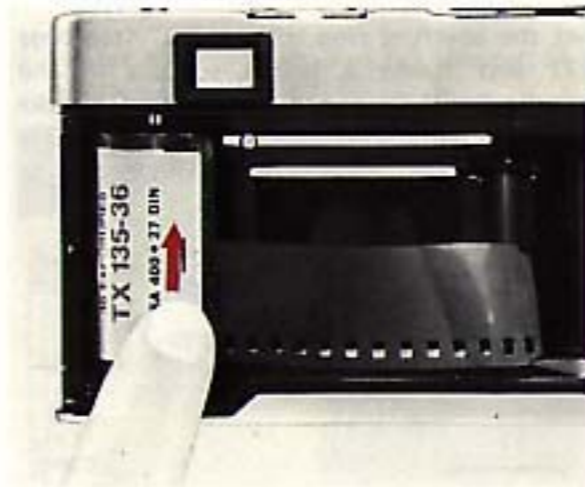

3. Insert film leader into one of the slots in the take-up spool and engage the second or third perforation from the end with the tooth on the slot.

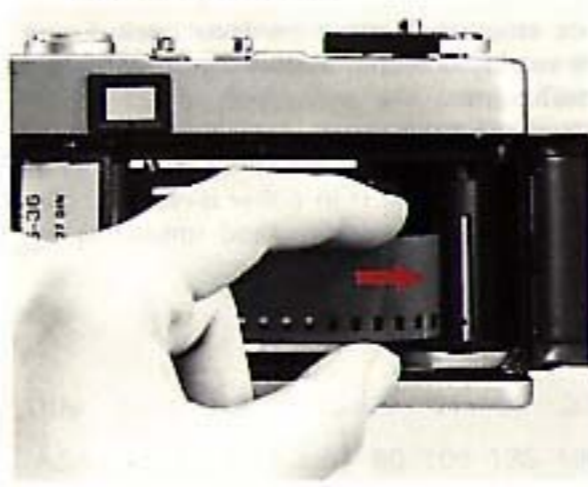

4. Pressing film gently against the sprocket, actuate film advance lever slowly until the perforations on both edges of the film are engaged with sprocket teeth. (If advance locks during this, release shutter and continue.)

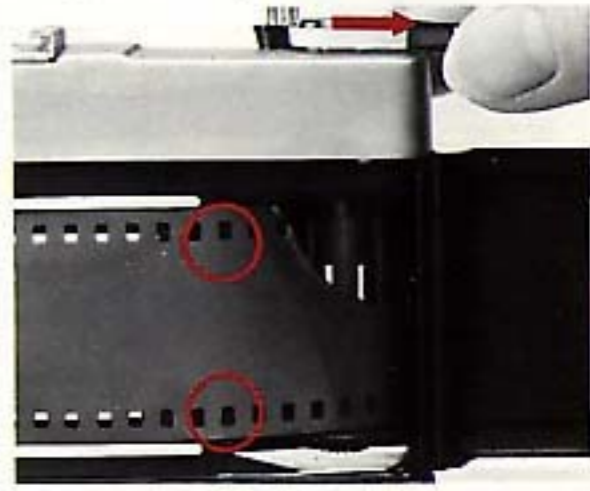

- 8 5. Close and latch the back cover.
6. Advance film and release shutter until the figure "1" appears in the center clear area of the frame counter as shown. Back-release knob and rewind crank should turn counterclockwise during the entire engaged stroke of the film-advance lever; if they do not, repeat the above steps to assure film is aligned and advancing properly.



CAUTION:

Do not depress the shutter button during winding. This will engage the shutter release mechanism and expose the next frame. After each full stroke, the film-advance lever will snap back to its offset position and can be folded in flush with the top cover. Do not attempt to move the lever back during its stroke, however, as this may damage the mechanism. When the lever resists advancing movement after the last exposure on a film, do not attempt to move it in either direction. (See page 20 for rewinding and unloading instructions.)

Setting film speed

Each film on the market has an ASA or DIN exposure-index number to indicate its sensitivity to light. To obtain correct exposure with the automatic exposure system of your camera, you must set it for the film in use. To do this, depress and position the film-speed lever located on the bottom of the lens barrel to the number that corresponds to the film ASA you are using. Dots between numbered graduations indicate ASA DIN numbers as follows:



DIN	15	16	17	18	19	20	21	22	23	24	25	26	27	28	29	30
ASA	25	32	40	50	64	80	100	125	160	200	250	320	400	500	640	800

HOW TO TAKE PICTURES

10 Focusing

Focus by looking through the viewfinder and moving the focus lever until the two subject images in the rangefinder square at the center of the viewfinder frame come together and appear as one.

Out of Focus

Your subject is not properly focused if a double image of it appears in viewfinder's square-shaped area as shown.



In Proper Focus

When the two images merge into one as shown, subject is in sharp focus. Camera-to-subject distance is indicated in both feet and meters by scales located on either side of the lens barrel.



Framing

For usual distances, compose your picture by framing your subject as you wish within the bright-frame visible in the viewfinder; the area inside this frame is what will appear on the film.

To correct for the slight difference in viewing angle between the viewfinder and the camera's taking lens (i.e., for parallax), frame subjects closer than about 1.2m (3.8 ft.) within the short curved line in the upper left corner of the frame.

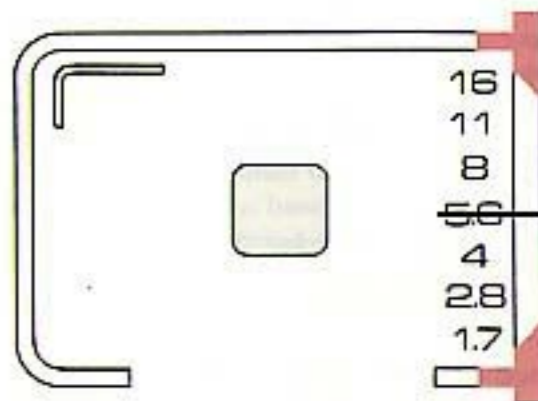

12 Automatic exposure

Your new 7s II is equipped with an automatic diaphragm coupled to an advanced electric eye system to combine maximum accuracy with the greatest possible operating ease. Once your camera set for automatic operation, you need only focus and press the shutter release button to take pictures under average daylight conditions. With the 7s II, even beginners and children can take perfectly exposed pictures as no photographic skill or experience is necessary.



To use your 7s II in automatic mode, simply turn the aperture ring until the red "AUTO" position is aligned with the index. Select an appropriate shutter speed for picture taking conditions (e.g. for ASA 80 film, use 1/125 sec. for a sunny day and average subjects). The camera's EE system will automatically select an aperture for most types of light situations.



Over/under exposure warning

When looking through the viewfinder, the aperture scale and indicator needle can clearly be seen on the right side. If the needle is clear of the upper or lower red warning zones, the automatic exposure system will function to give you proper exposure.

If the needle remains in the top warning zone, the shutter speed you have selected is too low and you should select a faster speed so that the needle will return to the working

aperture zone. If the needle remains in the lower warning zone you should use a slower shutter speed or in the case of dim light, conditions such as indoors or at night, use a flash. 13

CAUTION:

If the shutter speed selected is lower than 1/60 sec., there is a possibility of picture blur. In such case select a higher speed, use a tripod, or use a flash. If the aperture is in the top warning zone and the shutter speed is set at 1/500 sec., use an ND filter to reduce the light.

Overexposure



Underexposure



14 Manual exposures

For unusual conditions or for special effects, you may want to operate the camera manually selecting the aperture yourself. To use the camera manually, turn the aperture ring from AUTO position to any aperture selection. You are now in complete command of the camera and can set any shutter speed or aperture opening combination you wish.

NOTE:

In manual operation, the meter does not function, and the position of the indicator needle is the lower red warning zone.



"B" (bulb) setting

To use the bulb setting on your camera, depress the bulb lock release and turn the shutter speed ring until the "B" is aligned with the white index. The shutter will open when the shutter button is depressed and remain open until it is released.



Depth-of-field

When the lens is accurately focused, there is a certain depth considered to be in focus both in the foreground and the background. This is called "depth-of-field". Depth-of-field becomes deeper as the aperture opening is made smaller and shallower as the aperture opening is made larger.

At large aperture opening



At small aperture opening



Holding the camera

16 Horizontally

This position assures you of a better grip with less chance of moving the camera as you can hold it firmly with both hands. Press your elbows tight to your body and release the shutter gently in order to avoid movement of the camera.

It is best to focus with the right eye for sequence shooting in order to prevent the film advance from coming into contact with your face.



Vertically

The camera may be rotated to a vertical position when held this way, the only difference being that its rewind-crank end will rest in the palm of the left hand.



Using the self-timer

The self-timer delays shutter release for about 10 seconds after the shutter release button is pressed, allowing time for you to get into the picture yourself. To use the self-timer:

1. Advance the film.
2. Rotate the self-timer lever as far as it will go (somewhat over 90°) counterclockwise until it catches.
3. Press the shutter release button. The self-timer operates for about 10 sec., after which the shutter will be released automatically.



18 Flash pictures

You should use electronic or bulb flash for night or indoor photography, or in shaded areas.

1. The Minolta 7s II is equipped with a convenient hot-shoe contact for cordless flash use. When using the Minolta Electroflash 20 or other cordless units, all you have to do to attach the unit is slide it into the camera's accessory shoe.



2. Release the aperture ring from its "AUTO" position and turn it to the F-number obtained from flash calculation. To determine the correct aperture for flash photography, refer to the calculator or the guide number chart on your flash.



3. Determining aperture using the guide number.

(1) Find guide number on the flash guide number chart for the film speed you are using.

(2) Use the formula below to calculate the aperture number.

$$\text{Aperture (F-number)} = \frac{\text{Guide Number}}{\text{Distance to Subject}}$$

4. When using an electronic flash unit, you may use any shutter speed. If you use an M-class flash bulb, set the shutter speed to 1/30th sec. or slower.

In the case of automatic flashes such as Minolta's Auto Electroflash 25, simply set the aperture indicated on the flash computed dial for the film speed you are using, focus and shoot. The flash's automatic system will vary the light output

to give you proper exposure for the range indicated on the flash.

Focus and shoot your picture.

CAUTION:

- With flash attachments using standard flashbulbs, be sure not to insert a bulb until unit has been properly attached to camera.
- Be careful to push flash unit all the way into accessory shoe until it stops.

Rewinding and unloading film

1. Depress the rewind-release button on the bottom of the camera.

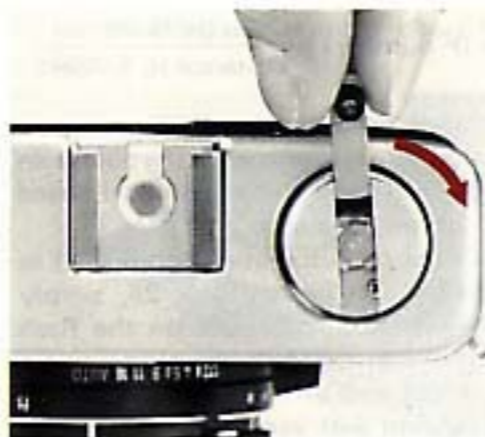

2. Fold out the rewind crank and turn it clockwise.
3. When you are sure the film is completely rewound and the crank turns freely, pull the back-release knob to open the cover and remove the film cartridge.

**OPTIONAL ACCESSORIES****Auto Electroflash 25**

This light, compact unit makes completely automatic electronic-flash exposures over a considerable range by means of a built-in sensor or can be used as conventional non-auto unit. Recycling condition is indicated by a monitor lamp. Guide number is up to 25 for meters at ASA 100, 41 for feet at ASA 25.

**Electroflash 20**

Specially designed for Hi-matic cameras, this compact and efficient electronic-flash unit features cordless, hot-shoe convenience. Guide number 20 in meters with ASA 100 film, 33 in feet with ASA 25. The Electroflash 20 can also be used on any camera equipped with a cordless hot shoe. The unit has a combined monitor lamp and test/open flash button.



22 Minolta Lens Shade

This lens shade prevents harmful extraneous light from entering the lens, and is recommended for all outdoor photography.



Minolta Filters

For-Black-and-White Film

UV: This filter absorbs excessive ultra-violet ray when shooting mountain, snow, sea and other distant scenes. It may be kept attached to protect the lens.

Yellow: This filter renders red and yellow subjects lighter than the eye sees them. It is often used to darken blue skies and emphasize white clouds.

For Color Film

80B: This filter is used for shooting with daylight-type color film indoors with artificial light of 3400° K color temperature.

For All Film

1A: Use this filter to improve bluish rendition of subjects in shade illuminated by blue sky, on overcast or rainy days, or obscured by atmospheric haze. It can also be used to protect the taking lens.

ND X4: This neutral density filter is used to adjust the amount of exposure. It is especially useful when there is a possibility of over exposure (For example, when shooting summer beach or brilliant snow scenes, especially with fast films).

DEPTH-OF-FIELD CHART

IN METER

F No. Dist. (m)	1.7	2	2.8	4	5.6	8	11	16
∞	∞	∞	∞	∞	∞	∞	∞	∞
5	26.4	23.1	16.3	11.0	8.2	5.8	4.1	2.9
3	6.14	6.35	7.15	8.71	12.0	34.4	∞	∞
2	4.22	4.12	3.85	3.51	3.13	2.71	2.29	1.86
1.2	3.37	3.43	3.65	4.01	4.67	6.07	10.0	∞
0.9	2.70	2.67	2.55	2.40	2.22	2.00	1.76	1.50
0.5	2.10	2.18	2.26	2.40	2.61	2.99	3.77	5.09
0.3	1.86	1.85	1.79	1.72	1.62	1.51	1.37	1.21
0.2	1.25	1.20	1.29	1.33	1.39	1.48	1.65	1.85
0.1	1.15	1.15	1.12	1.10	1.06	1.01	0.95	0.87
0.05	0.93	0.93	0.95	0.97	1.00	1.05	1.12	1.25
0.03	0.87	0.87	0.86	0.84	0.82	0.79	0.75	0.70

IN FEET

F No. Dist. (ft.)	1.7	2	2.8	4	5.6	8	11	16
∞	∞	∞	∞	∞	∞	∞	∞	∞
15	86' 7 ¹ / ₂ "	75' 8 ⁵ / ₁₆ "	53' 7 ¹ / ₂ "	37' 11 ¹ / ₂ "	26' 10 ¹ / ₁₆ "	19' 3 ¹ / ₂ "	13' 5 ⁵ / ₁₆ "	9' 6 ⁵ / ₁₆ "
7	18' 9 ¹ / ₁₆ "	18' 7 ³ / ₁₆ "	20' 8 ¹ / ₁₆ "	24' 8 ¹ / ₁₆ "	33' 4 ¹ / ₁₆ "	68' 2 ¹ / ₁₆ "	∞	∞
5	12' 9 ⁹ / ₁₆ "	12' 6 ⁹ / ₁₆ "	11' 9 ⁹ / ₁₆ "	10' 9 ⁹ / ₁₆ "	9' 8 ¹ / ₁₆ "	8' 5 ¹ / ₁₆ "	7' 2 ³ / ₁₆ "	5' 11"
3	7' 2"	7' 8 ¹ / ₁₆ "	8"	8' 8 ¹ / ₁₆ "	9' 4 ¹ / ₁₆ "	10' 10 ¹ / ₁₆ "	14' 9 ¹ / ₁₆ "	24' 4 ¹ / ₁₆ "
2	6' 0"	6' 5 ¹ / ₁₆ "	6' 2 ¹ / ₂ "	5' 11 ¹ / ₂ "	5' 7 ¹ / ₁₆ "	5' 2 ¹ / ₁₆ "	4' 8 ⁵ / ₁₆ "	4' 1 ¹ / ₂ "
1.2	5' 3 ³ / ₁₆ "	5' 3 ³ / ₁₆ "	5' 8 ¹ / ₁₆ "	5' 8 ¹ / ₁₆ "	6' 3 ¹ / ₁₆ "	6' 7 ³ / ₁₆ "	7' 8 ⁵ / ₁₆ "	9' 11 ¹ / ₁₆ "
0.9	4' 0 ⁹ / ₁₆ "	4' 8 ¹ / ₁₆ "	4' 7 ³ / ₁₆ "	4' 5 ¹ / ₁₆ "	4' 3 ¹ / ₁₆ "	4' 3 ¹ / ₁₆ "	3' 8 ⁵ / ₁₆ "	3' 4 ⁵ / ₁₆ "
0.5	4' 2 ¹ / ₁₆ "	4' 2 ¹ / ₁₆ "	4' 3 ⁵ / ₁₆ "	4' 5 ¹ / ₁₆ "	4' 7 ¹ / ₁₆ "	4' 11 ¹ / ₁₆ "	5' 6 ⁵ / ₁₆ "	6' 6 ⁵ / ₁₆ "
0.3	3' 10 ¹ / ₁₆ "	3' 9 ⁹ / ₁₆ "	3' 8 ⁵ / ₁₆ "	3' 7 ³ / ₁₆ "	3' 6 ¹ / ₁₆ "	3' 4 ¹ / ₁₆ "	3' 1 ³ / ₁₆ "	2' 10 ¹ / ₁₆ "
0.1	3' 1 ¹ / ₁₆ "	3' 1 ¹ / ₁₆ "	3' 1 ¹ / ₁₆ "	3' 2 ¹ / ₁₆ "	3' 4"	3' 5 ⁵ / ₁₆ "	3' 8 ¹ / ₁₆ "	4' 2 ⁵ / ₁₆ "
0.05	2' 10 ⁵ / ₁₆ "	2' 10 ⁵ / ₁₆ "	2' 10 ⁵ / ₁₆ "	2' 9 ⁵ / ₁₆ "	2' 8 ¹ / ₁₆ "	2' 7 ⁵ / ₁₆ "	2' 6 ⁵ / ₁₆ "	2' 4 ¹ / ₁₆ "

SPECIFICATIONS

24

- Type: Compact 35mm camera with automatic exposure control
- Lens: Rokkor 40mm f/1.7, 6 elements in 4 groups, 57° angle of view; 49mm screw-in lens-shade and filter mount
- Shutter: Copal mechanical type with settings of 1/8, 1/15, 1/30, 1/60, 1/125, 1/250, 1/500 plus B with safety lock
- EE System: CdS cell coupled to aperture mechanism for fully automatic exposure control; shutter speed priority system; exposure range of EV 4.5 to EV 17 with film speed range of ASA 25 to 800; automatic compensation when filters used; powered by one 1.3v mercury cell, Eveready EPX-675 or equivalent; aperture settings of f/1.7 through f/16 possible in manual operation
- Flash: "Hot-shoe" operation; circuit for X synchronization; electronic flash at all speeds; M-class bulbs synchronizes at 1/30 or slower
- Focusing: Direct helicoid type; with coupled super imposed-image range-finder; minimum focusing distance 0.9m (2.7 ft.)
- Viewfinder: Bright-frame type with parallax correction mark; f-number setting and under/overexposure warning indicated on scale by needle
- Film advance: Lever type with single 130° stroke after 30° unengaged play; automatic resetting frame counter shows number of frames exposed
- Self-Timer: Approx. 10 sec. delay
- Frame Size: 24mm x 36mm standard 35mm film
- Size: 72mm (2-13/16 in.) high x 115mm (4-1/2 in.) wide x 59mm (2-5/16 in.) deep over-all
- Weight: 460g (16-1/4 oz.)
- Accessories: Lens shade, filters UV, Y48, ND 80B, 1A

CARE AND STORAGE

- Your Minolta Hi-matic 7s II is made for long, carefree service. But there are a few things that you should do.
- Never touch the camera lens with fingers. Should lens become dirty, clean it with a blower lens brush or soft, lint-free cloth, using a gentle motion.
- If you do not plan to use your camera for a long period of time, it is best to remove the batteries.
- Store your camera in a cool, dry place away from dust or chemicals. An airtight container that has drying agent like silica gel in it would be ideal.
- Camera should never be placed or left in glove compartment or other place in motor vehicles or elsewhere in which it may be subject to relatively high temperatures.
- If you have any questions, ask your Minolta dealer. He is knowledgeable in all aspects of photography, and can help you with all your photographic needs.

Specifications subject to change without notice

Minolta Camera Co., Ltd., 30, 2-Chome, Azuchi-Machi, Higashi-Ku, Osaka 541, Japan
Minolta Corporation, 101 Williams Drive, Ramsey, New Jersey 07446, U.S.A.
Minolta Camera (Canada) Inc., 1344 Fewster Drive, Mississauga, Ontario L4W, 1A4 Canada
Minolta Camera Handelsgesellschaft m.b.H., Kurt-Fischer-Strasse 50, D-2070 Ahrensburg, West Germany
Minolta France S.A., 357 bis, rue d'Estienne d'Orves 92700 COLOMBES France
Minolta Vertriebsgesellschaft m.b.H., Seidengasse 19, A-1072 Wien, Austria
Minolta Nederland B.V. Groen van Prinstererlaan 114 Amstelveen Nederland
Minolta Hong Kong Limited, 49 Chatham Road, Kowloon, Hong Kong
Minolta Singapore (Pte) Ltd., Chin Swee Tower, 52-E, Chin Swee Road, Singapore 3