

Japan : Olympus Optical Co., Ltd.
7, 3-chome, Kanda Ogawamachi
Chiyoda-ku, Tokyo

U. S. A. : Olympus Corp. of America
39-22, 30th Street, Long Island City
N. Y. 11101

Germany : Olympus Optical Co., (Europa) GmbH
Steindamm 105, 2 Hamburg 1

Olympus
Pen

FT

This Olympus Pen FT is the only half frame single-lens reflex camera in the world that has adopted the most advanced Through The Lens system. It meets all requirements for a contemporary high quality camera. To take fine pictures, you need first to familiarize yourself with your camera. Read these instructions carefully before picture taking.

● Explanations are given on how to handle the various parts. Read the explanations according to the leader numbers illustrated.

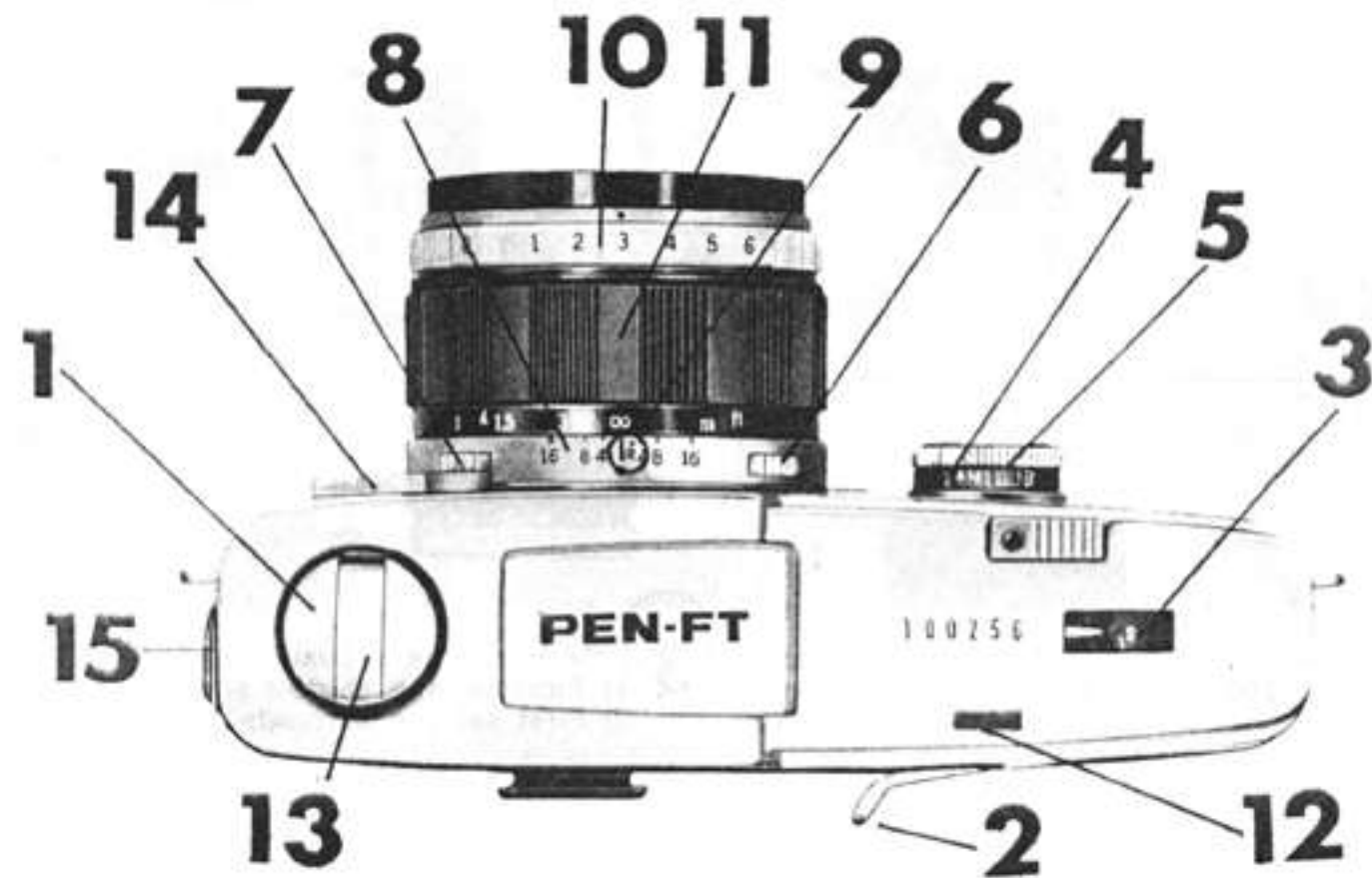



1 Load the camera (see page 15).



2 Set the ASA rating of your film (see page 10).

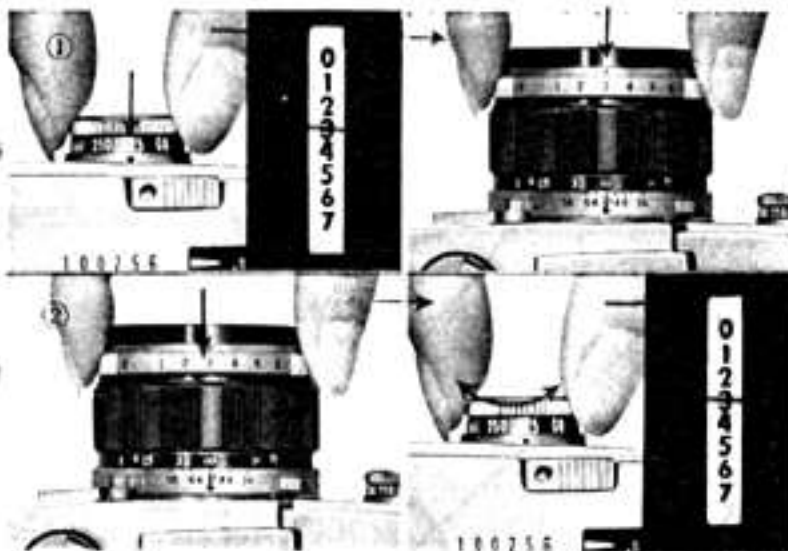

3 Determine the exposure. (see page 18)
1) First set the shutter speed, or
2) First set the Through-The-Lens number.



4 Advance the film. (see page 9)



5 Hold the camera steady and compose your picture (see page 20)



6 Set the focus (see page 14).



7 Press the shutter button quietly.

Component parts:

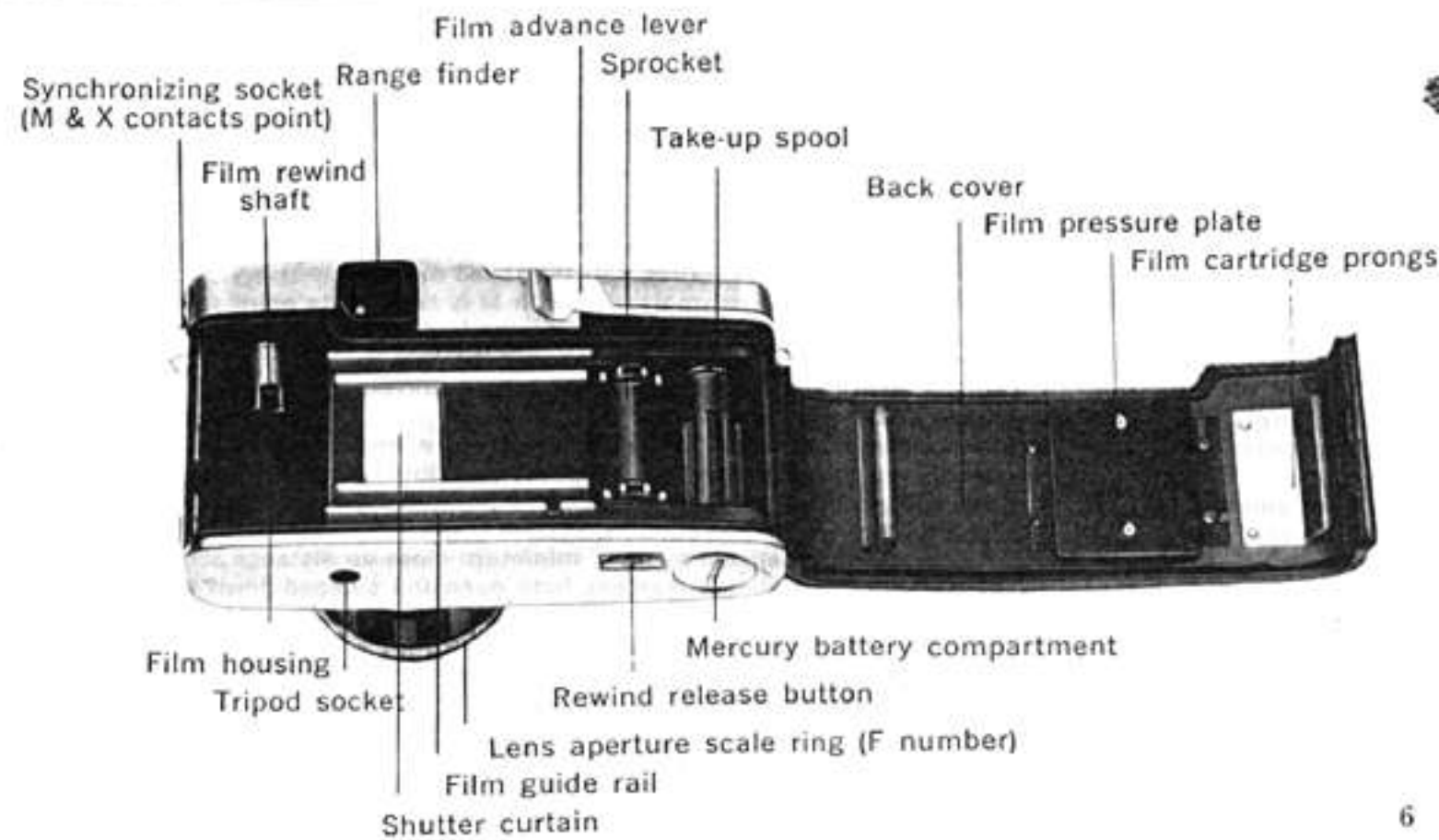
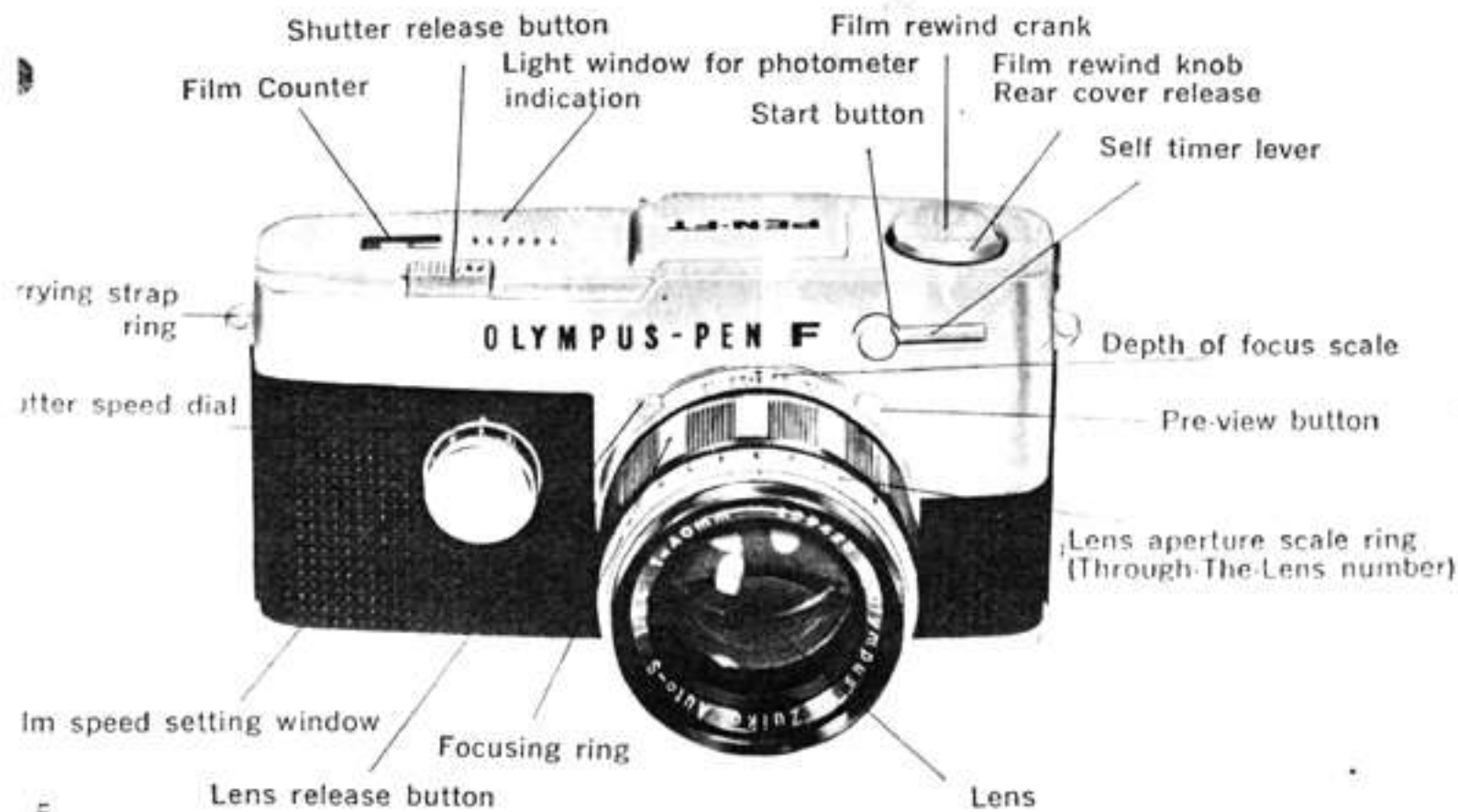

Main features:

FT

Picture size	: 24×18 mm
Lens	: (with F1.2 standard lens) H Zuiko Auto S, F1.2, f=42mm, (with F1.4 standard lens) G Zuiko Auto S, F1.4, f=40mm, (with F1.8 standard lens) F Zuiko Auto S, F1.8, f=38mm, All lenses have fully automatic diaphragm and are marked on Through-The-Lens numbers and F-numbers.
Lens replacement	: Bayonet system ("Pen" mount)
Shutter	: Olympus rotary metal focal-plane shutter; B, 1-1/500 sec. (equally calibrated) one-pivot non rotating shutter speed dial
Synchronizing	: All shutter speeds synchronization with M & X contacts point switch
Viewfinder	: Porroprism finder, magnification 0.8X (standard lens), with microprism and special Fresnel lens
Mirror	: Horizontally opening shockless quick return mirror
Loading	: EL (easy loading) system
Film advancing	: 1-stroke lever type with an advancing stroke angle of 150 degrees, self-cocking to prevent double advances and double exposures
Film counter	: Exposed counting, self-resetting type
Film rewinding	: Crank type rewind button setting system
Focus adjustment	: Direct advancing helicoid system, minimum close-up distance 35cm
Exposure adjustment	: Through-The-Lens number system, both open and stopped-down aperture methods available
Light measuring range	: EV3~EV17 (ASA 100) with F1.4 standard lens
Light acceptor	: Extra-large CdS meter, average light measurement method
Power source	: Mercury battery (1.3 volts)
Film speed rating scale	: ASA 25-400
Self-timer	: Lever system (90 degrees) actuated in about 11 seconds
Rear cover operation	: "Magic" locking hinge system
Size & weight	: (with F1.2 standard lens) 127 (W)×69.5 (H)×77.5 (D) mm, 720 gr. (with F1.4 standard lens) 127 (W)×69.5 (H)×68.5 (D) mm, 630 gr. (with F1.8 standard lens) 127 (W)×69.5 (H)×62.5 (D) mm, 600 gr.

Fitting the mercury battery:

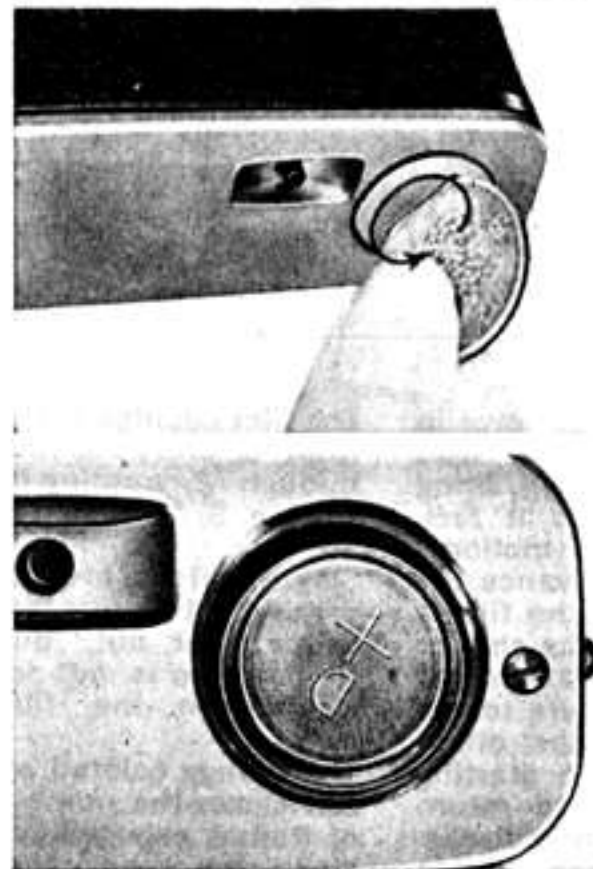
FT

To actuate the light meter, insert the mercury battery (1.3V) correctly into the battery compartment at the bottom of the camera. The battery is the power source for built-in exposure meter.

1. Fit a coin into the slot on the cover of the battery compartment and turn the cover counter-clockwise for removal.

2. Put in the battery, as illustrated, so that the (+) end of the battery faces outwards, and screw in the cover firmly.

When the battery runs out, its performance fails sharply and the meter ceases to function. Take care to replace the battery after about one year of use.

Recommendable batteries are replacement National M-1D, Toshiba TH-MC, Mallory RM 625, Eveready E625, General No. 625, etc.

1 Opening the back cover:

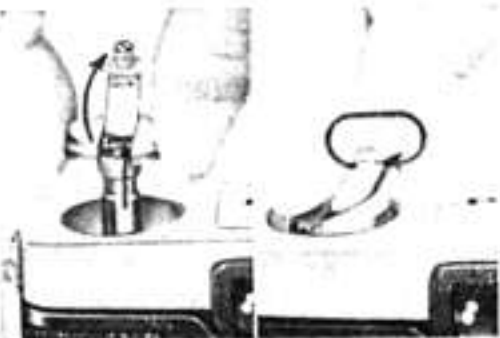

Lift the film rewind crank and pull up the knob until it comes to its first stop. At this point, pull it up further; then the rear cover opens automatically. To close it, press the cover until it clicks. To rewind the film (see page 19) or tighten the film (see page 18), turn the rewind crank in the direction of the arrow.

2 Operating the film advance lever:

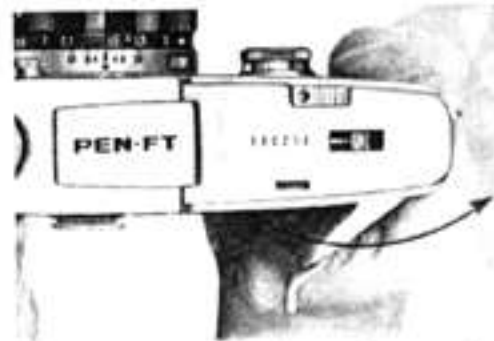

1. Move out the advance lever in a single stroke (preliminary lead angle 13°). In picture taking, bring the lever to this point, as it facilitates the next advancing motion.

2. From this point, advance the lever until it stops, then the film is advanced one frame and the shutter release can be actuated (advancing stroke angle 137°). Be sure to advance the lever until it stops; otherwise it does not return to starting position. Don't force it to return from the middle position of a stroke.

3. Squeeze the release button gently; then the shutter is actuated and the film can be advanced for the next exposure.

3 Film counter:



The film counter starts from "S" and continues through 72, counting by 4 s. i. e. S, 1, 4, 8, 12, 16, etc.

Single frames are advanced by the film advance lever but, due to size, this is not indicated on the film counter.

The orange colored arrow shows the number of frames exposed.

When the rear cover is opened, the film counter returns to "S" automatically.

4 Shutter speed dial:



The shutter dial shows shutter speeds, B, 1, 2, 4, etc., up to 500.

To set shutter speed, turn the dial until the corresponding number is aligned with the red dot. B (bulb)—In this setting, the shutter leaf is opened when the shutter release button is pressed, and will remain open until it is released. B is used when exposures of longer than one second are desired. The numbers 1 through 500 stand for fractions of a second, i. e. 1=1 sec., 2=1/2 sec., etc. through 500=1/500 sec. The shutter dial is not turned between B and 500. (one-pivot nonrotating system)

For the correct speed, ensure that the number is perfectly matched with the red dot. Speed may be set either before or after advancing the film.

5 Film speed setting window:



The small window located between B and 1 on the shutter dial is the film speed setting window. Pull out the shutter dial ring slightly and turn it to have the ASA rating of your film appear at the center of the window.

ASA scale: 25, (32), (40), 50, (64), (80), 100, (125), (160), 200, (250), (320), 400

6 Lens release button (lens replacement):

Bayonet-mounted lenses for the Pen FT are easily removed and replaced. On the base of the lens, there are two buttons, one of which is marked with a red L (Lock). This is the lens release button.

First, hold the camera in the left hand and grasp the base of the lens with the right hand. Then press the lens release button with the thumb of the right hand and turn the lens in a clockwise direction until it stops. The lens is removed by pulling it away from the camera body.

To remount the lens, insert it carefully into the body, aligning the red mark (L) on the lens with the red dot on the body. Turn the lens in a counter-clockwise direction until the lens release button (L) returns with a click.

It is not necessary to move the lens release button when mounting the lens.

Lens dismounting



Lens mounting

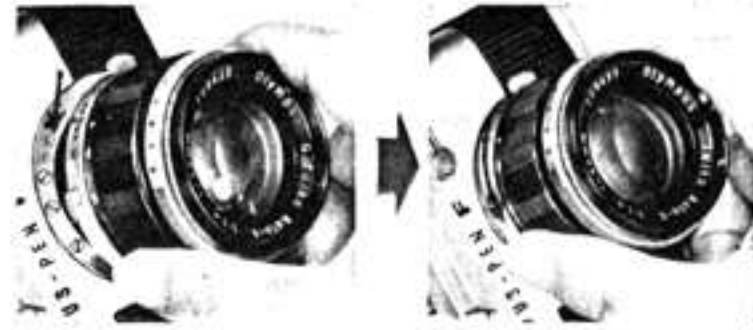

7 Pre-view button (to verify F/stop selection):

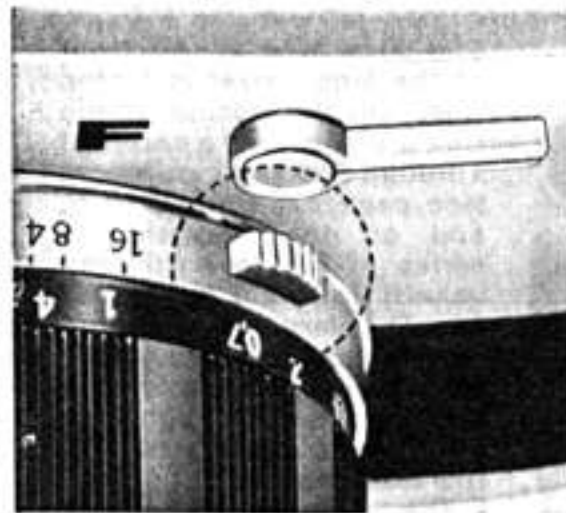

The unmarked button on the base of the lens is called the "Pre-view button". Even after the F/stop on the Pen FT is set, it will not close down to this opening unless the shutter release button is pressed. At all other times the lens diaphragm is wide open. This fully automatic diaphragm system allows focusing and framing at full brightness.

The pre-view button on the Pen FT closes the pre-set opening, making it possible to see the subject through the viewfinder with the same brightness as that of the F/stop setting. (See section 8 & 11, Depth of Focus & Distance Scale.) This ensures perfect focusing of both subject and background.



8 Reading the depth of focus scale:

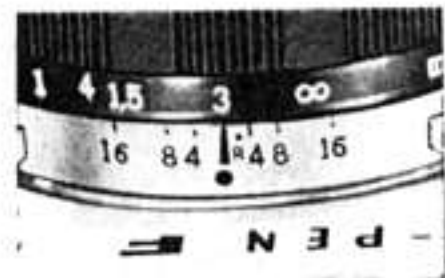

The depth of focus is indicated by a set numbers; 4, 8 and 16; which correspond to lens openings and are written on each side of the red mark (L). Reading the depth of focus is explained by the following example: The distance between the camera and the subject is 3 meters and the F/stop setting is 16. Depth of focus is indicated between 16 to the left of the mark (1.5 m) and 16 to the right of the mark (∞)

The focused range can also be determined by pressing the pre-view button while viewing through the finder, as explained in Section 7.

9 The "R" scale:

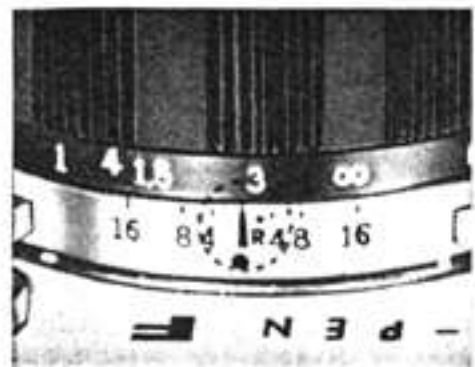

This is the infra-red indicator. To use infra-red sensitive film, set the focus first, and then reset the focus to be line to the "R" mark. Infra-red photography requires a red filter.

10 F/Stop ring:

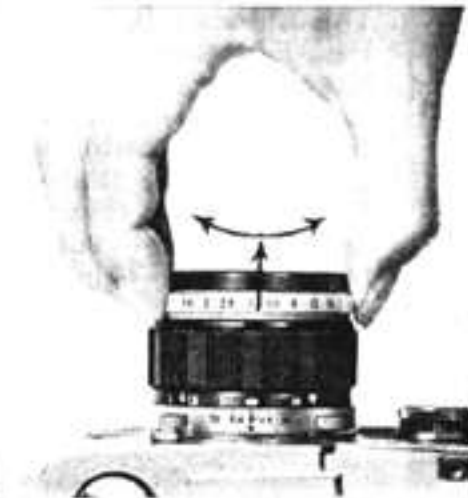

The silver ring at the front of the lens barrel is F/stop ring. On the upside of the ring are engraved a series of Through-The-Lens numbers (see page 17) from 0 to 6, and on the downside a series of F-numbers (F/stop values) from 1.4 or 1.8 to 16. The larger the F/stop number, the smaller the F/stop value. Turn this ring and align the Through-The-Lens number you need with the black center dot.

* The Through-The-Lens number can use midway scale readings which the shutter speed cannot.

* Pull forward the F/stop ring and turn it around then you can set F-number on the upside.

* To verify complete setting, make certain that the two ends of the ring do not move after the ring has been set.

11 Distance scale ring:

While viewing through the finder, turn the distance scale ring in either direction until the subject is most clearly visible. Thanks to a microprism installed, you can get a sharp focus so easily. The shutter release button may then be pressed. Clear, sharp photography.

The distance scale ring has scales in two different colors; white (meters) and yellow (feet). These indicate distance between the camera and the subject in focus. A big feature of Pen FT is that it permits close-up photography up to 35cm without use of any accessory.



Loading the camera:

FT

The Pen FT uses standard size 35mm film, which is available anywhere.

The pictures are "Pen" size (15/16x11/16 inches), half of the 35mm film size (13/8x17/8 inches). This size is very economical, especially for colored slides, because 72 pictures can be taken on a roll of 36 and 40 on a roll of 20.



1 Open the rear cover. (see page 9)

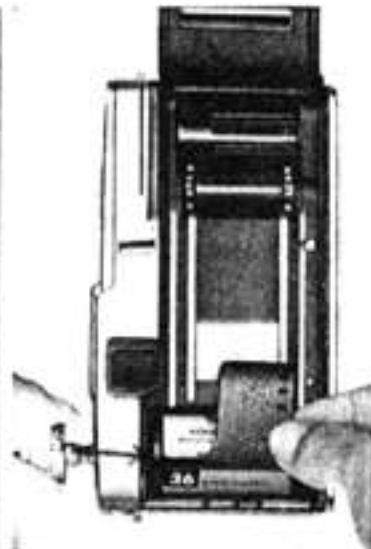

2 Put the film into the film compartment. If the rewind knob does not return to its home position, press it in while slightly turning it clockwise or counter-clockwise; then it clicks in easily.

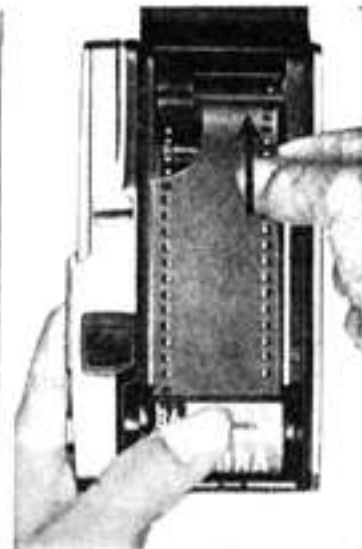

3 Hold and lead out the film a little with the right hand while slightly pressing the cartridge with the left hand and insert the film end into any of the six grooves on the take-up spool.

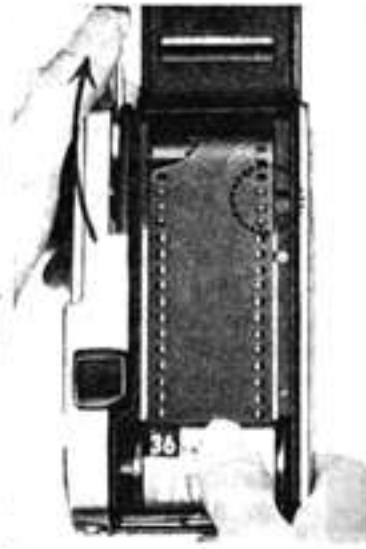

4 Advance the film so that the perforations engage the sprocket gear. *When the film is inserted in, the film end may run out of the other side of the spool. Even in that case, continue to advance the film.

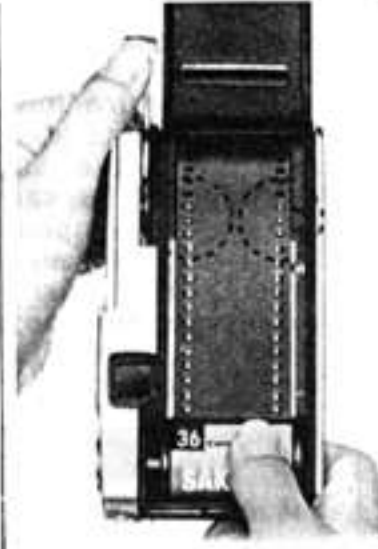

5 At this point, actuate the shutter and advance the film further so that the perforations on both sides engage with the sprocket gear.

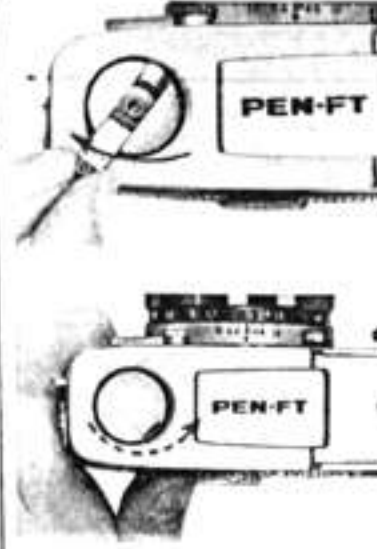

6 Close the rear cover. At this point, for additional safety, lift up the rewind crank and turn it lightly until it meets resistance indicating that the film is tightened enough.

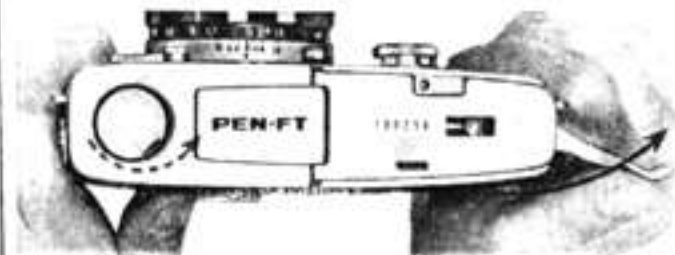

7 Operate the advance lever and actuate the shutter. Repeat this motion until the film counter shows the number 1. From this point, start taking pictures. If the rewind knob turns during the repeated motion, this shows that the film is being advanced properly.

● Through-The-Lens Metering System

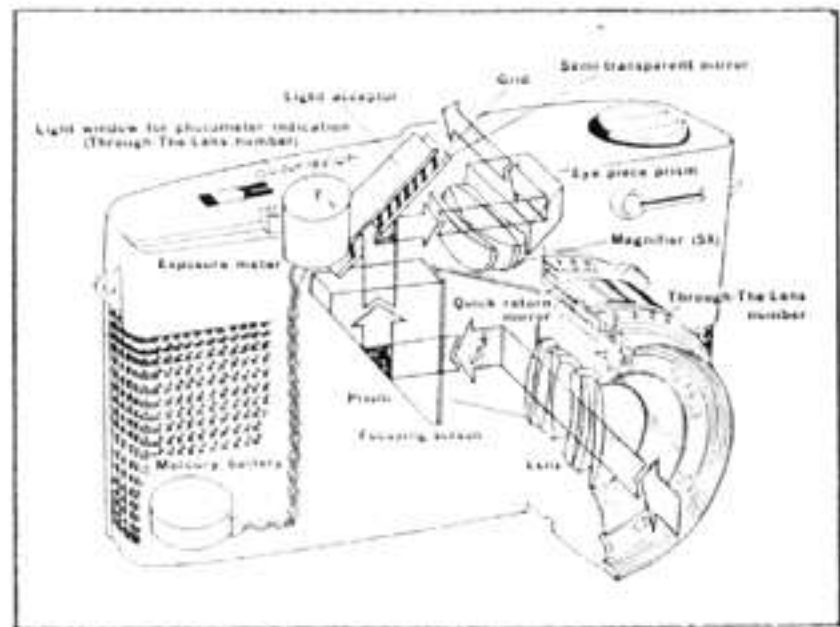

The Through-The-Lens system to measure the amount of light passing through the taking lens operates in two different ways; the open aperture and stopped-down aperture methods. The Olympus Pen FT permits applying either the "open aperture" or the "stopped-down aperture" method with the same lens and moreover completely compensates for all measurement errors talked about on conventional Through-The-Lens system cameras. It represents the most advanced Through-The-Lens system ever developed in the world. Looking through the viewfinder,

you see the photometer indication window at the left hand. The window carries a series of Through-The-Lens numbers from 0 to 7. These numbers enable you to determine the correct exposure with ease.



● Photometer indication window

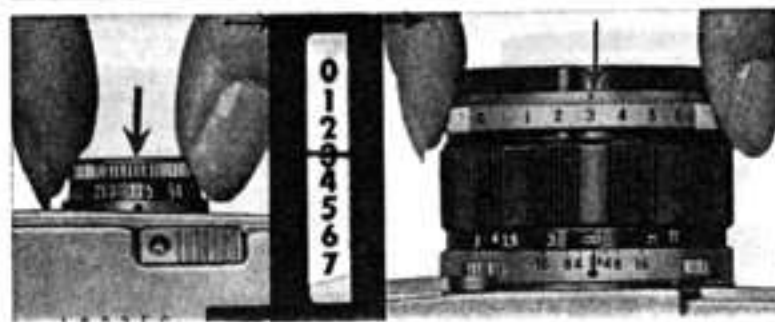

1 When you first determine the shutter speed:

First determine the proper shutter speed according to the conditions of your subject. Select 1/30 or 1/60 of a second for indoor photography or dim subject; 1/125 or 1/250 of a second for outdoor photography or bright subjects. Next look at your subject through the viewfinder, read the Through-The-Lens number indicated by the pointer, and set that number to Through-The-Lens number marked on the F/stop ring. Then you have the correct exposure.

* When the light meter window index enters the top or bottom red zone, it means the shutter speed preset is not proper. Reset the speed.

Note: *When the shutter speed is set at 0.5 or 1 second, meanwhile, a red shift zone appears.

*When the black needle in the light meter window enters the top or bottom red zone and/or point out the Through-The-Lens number that is not marked on the Lens aperture scale ring, it means the

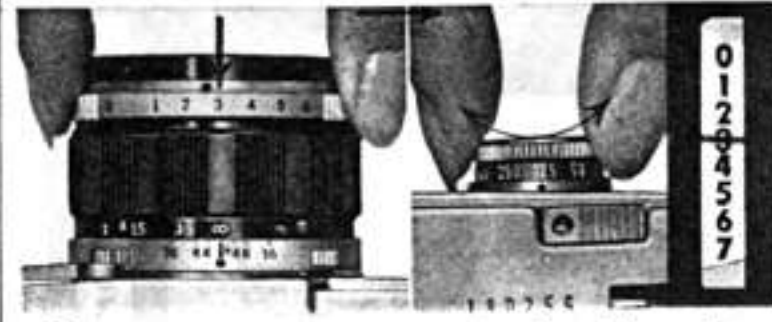

2 When you first determine the Through-The-Lens number:

First set the proper Through-The-Lens number marked on the F/stop ring according to the conditions of your subject. (Consult the F-number appearing on the downside of the ring.) You should take 1 or 2 for indoor photography or dim subjects and 4 or 5 for outdoor photography or bright subjects. Next looking at your subject through the viewfinder, turn the shutter dial, and have the pointer of the photometer indication window indicate the Through-The-Lens number just you pre-set. Then you have the correct exposure.

* Note that you will have the B (bulb) exposure if you turn the shutter dial counter-clockwise till it stops.

(Stopped-down aperture method)



Determine your exposure by the stopped-down aperture method if you wish to measure the amount of light with the same brightness as that of the aperture setting pressing down the pre-view button or when you practice special photography.

Look through the viewfinder with the aperture stopped down and adjust with either the shutter dial or the F/stop ring so that the pointer of the photometer indication window may indicate the minimum Through-The-Lens number engraved on the ring. Now you have the proper exposure.

● Attachment of Eye correction lens adapter is recommendable for measuring secure light condition.

How to utilize the old interchangeable lenses:



Owners of the Olympus interchangeable lenses without Through-The-Lens numbers can stick this Through-The-Lens number seal to the lenses when using them.

● How to stick the seal:

- 1) Strip off the back paper of the seal.
 - 2) Stick the seal to the aperture ring surface that is inscribed with the F numbers. Keep the ring open (click stop), stick the seal so the first number on the seal may fit to the index.
- * Length of the seal is equal to that of the surface inscribed with the F numbers.

● Note: Take care not to rub the seal or wipe it with such chemicals as alcohol or ether, in which the numbers will be erased.

Holding the camera properly:

The camera must be held firmly in order to take good pictures. Shaking leads to unsharp pictures. Practice until you become fully accustomed to the "feel" of the camera. Squeeze the release button with the ball, not with the tip of your finger. You may hold the camera either vertically or horizontally as your composition requires.



When holding the camera horizontally, keep both elbows close to your body (Illustration).



When holding the camera vertically, keep the right elbow close to your body and support the camera firmly with the left arm (Illustration).

13 Rewind the film:

FT



When the whole roll has been exposed, cover the lens with the cap and rewind the film. To determine whether the whole roll has been exposed or not, check the film counter. It will show the number 72 (in the case of 36-exposure roll) or 40 (in the case of 20-exposure roll).

To rewind the film, first press in the rewind button at the bottom of the camera, then lift up the rewind crank and turn the crank in the direction of the arrow. While the film is being rewound, the crank is tight, but when the film is rolled up and the film end leaves the take-up spool, the crank suddenly turns freely.

The film thus rewound is taken out in a place free from direct sunlight.

Towards the end of the roll of film, the advance lever may meet resistance and refuse to move halfway through the advancing stroke. This means that all the film is used up. Do not attempt to force the lever or you will damage the camera and tear the film. Press the rewind button and you can then complete the winding stroke. Do not try to take another picture but rewind the film

14 Self-timer photography:

FT

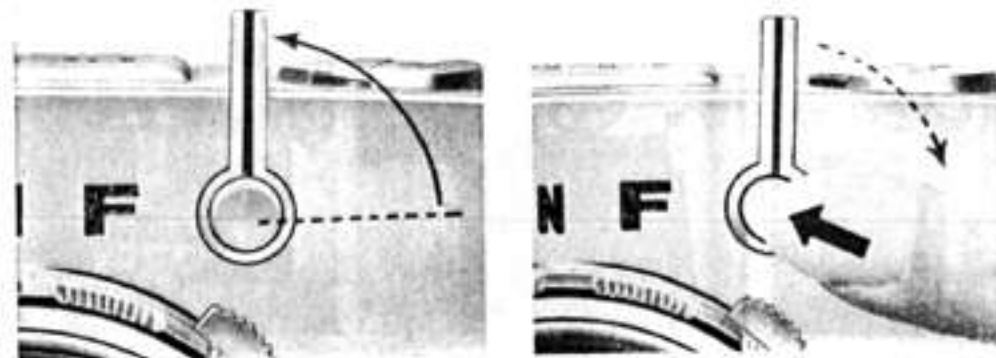

The camera has a built-in self-timer which enables you to take a picture of yourself without the help of others. Create a lot of happy photographic mementos by making effective use of the self-timer.

1. Set the self-timer by turning the lever 90 degrees upward.
2. Make certain the film has been advanced securely.
3. Press the start button at the center of the lever; then the shutter is actuated in about 11 seconds.

* You may set the self-timer lever either before or after advancing the film.

* Even after the self-timer has been set, you can also shoot by pressing the release button without operating the self-timer.

* When the film has not been advanced securely, the shutter cannot be actuated even if you operate the self-timer.

* If the above situation has taken place, turn the self-timer 90 degrees upward over again, and holding it with your finger, advance the film securely. At this time, the self-timer starts as your finger leaves it even you don't press the start button.

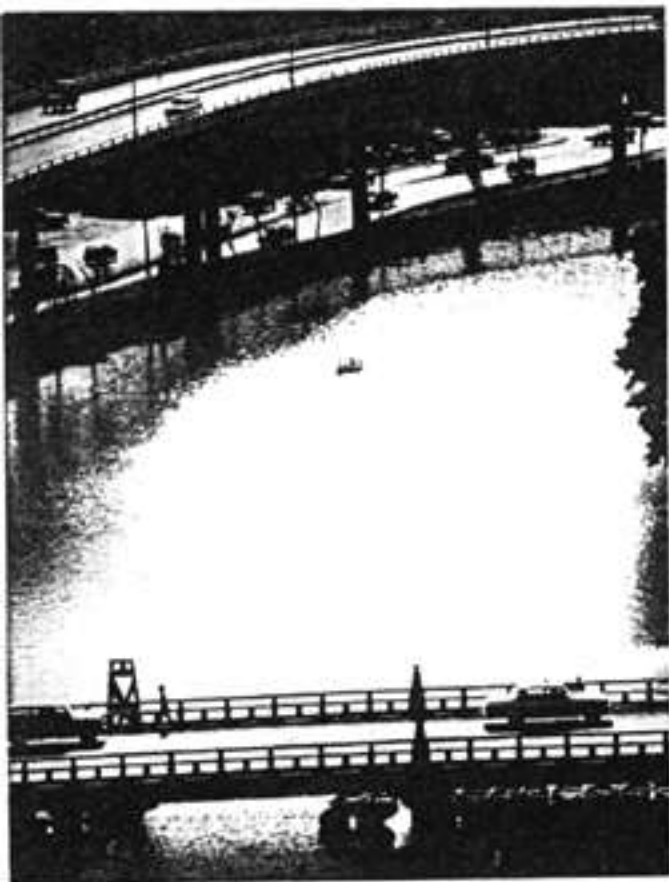

The real fun of single-lens reflex cameras—that's to make full use of interchangeable lenses. The Olympus Pen FT has an ample variety of interchangeable lenses including wide angle, telephoto, super-telephoto and zoom lenses in addition to standards, which wholly incorporate the easy-to-use quality of the Pen FT designed to superminiature size and light weight. They expand the pleasures of photography. The excellent description of the "Zuiko", indisputably a top quality lens of worldwide fame, will never fail to fascinate you.

← Used telephoto lens 100mm

● HIGH QUALITY OLYMPUS INTERCHANGEABLE LENSES

— EXCELLENT EYES OF THE PEN FT



● ENRICHED RANGE OF INTERCHANGEABLE LENSES FOR OLYMPUS PEN FT

INTERCHANGEABLE LENSES			Lens Component (elements-groups)	Angle of View	Focal Length Equivalent to 35mm Camera	Through-The-Lens Number	Minimum Distance	Filter	Weight
STANDARD LENS	H Zuiko Auto S	F1.2, f=42mm	8-6	39°	60mm	0-6	35cm	49mm	255gr.
	G Zuiko Auto S	F1.4, f=40	7-6	41	58	0-6	35	43	165
	F Zuiko Auto S	F1.8, f=38	6-5	43	55	0-6	35	43	135
WIDE ANGLE LENS	E Zuiko Auto W	F4.0, f=25	5-5	62	35	0-4	25	43	120
	G Zuiko Auto W	F3.5, f=20	7-6	73	28	0-4	20	43	145
	G Zuiko Auto T	F1.5, f=60	7-5	28	85	0-6	0.8m	49	270
TELEPHOTO LENS	F Zuiko Auto T	F2.0, f=70	6-5	24	100	0.5-7	0.8	43	230
	E Zuiko Auto T	F3.5, f=100	5-4	17	143	1-6	1.5	43	250
	E Zuiko Auto T	F4.0, f=150	5-4	12	210	1-5	1.7	49	380
	E Zuiko T	F5, f=250	5-3	7	360	1-6	3.5	58	800
SUPER-TELEPHOTO	Zuiko Mirror T	F8.0, f=800	6-5	2	1,150	(0)	15	25.5	2,000
ZOOM LENS	Zuiko Auto Zoom	F3.5, f=50-90	10-8	34-19	70-130	0.5-4	1.5	49	420
	Zuiko Zoom	F5, f=100-200	12-9	17-9	143-286	1-6	1.7	49	700



Filters
43mm
49mm

UV, Y2
1A
81C, 82C
Conversion A



Lens hood



Set case

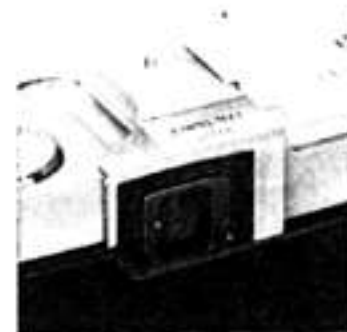

Accessory shoe

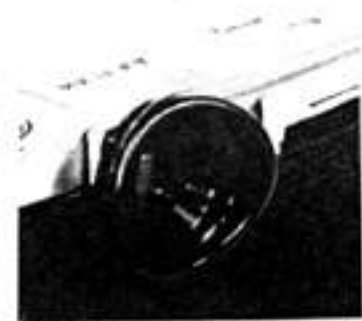

Eye correction lens adapter
Eye correction lens



Attachment lens
(close-up lens)
 $f=30\text{ cm}$ & $f=40\text{ cm}$



Extension tube



Extension ring set

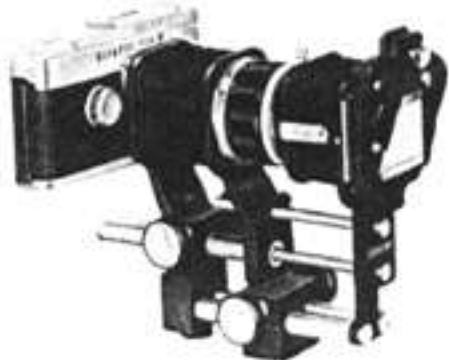

Bellows attachment
Slide copier
Camera slider



Pen up 3



Microscope adapter



Pen stand
(Pen F copy stand)
Light arm



Magnifier



Angle finder



Angle-magnifier



Praktica mount adapter

Exakta mount adapter

Leica mount adapter

Nikon mount adapter

Pen slide projector 2
Cooler (Blower)
Auto slide changer
Strip film carrier
Pen slide mount

