

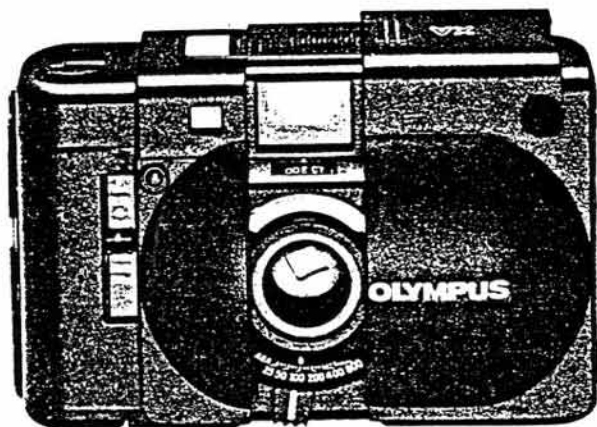

REPAIR MANUAL



OLYMPUS OPTICAL CO., LTD. TOKYO, JAPAN

EXPLANATION OF MARKS

① Indicates parts that are supplied both as a single piece and as an assembled unit. In the latter case, the single part is incorporated in the assembled unit indicated with the mark ①.
Exception: Parts in the mark () are not supplied in single pieces.
(Parts that are supplied only in single pieces are not indicated with any mark. While parts that are supplied as an assembled unit are prefixed with "Z" or "U".)

] Several types of parts for the same position are available, from which most suitable one is to be selected.

* 3 Parts differ according to different models and types. This mark is used to indicate various combinations in a picture.

⤵ Left-handed screw. The mate screw hole is not marked particularly.

⊠ Indicates parts that should not be touched directly by bare hand because special surface treatment is applied. Wear fingerstalls or use tweezers.

★ Not supplied as a repair part.

□ Used exclusively for black finish models.

— Indicates original parts. New, modified ones are not indicated with this mark. Both original and modified parts are supplied.

== No more available parts due to design change or out of stock.

✕ A correction mark. Parts with this mark are not available.

< 2 > Modified parts that are unable to show in the technical manual. The figure indicates reference page number.

2-A3 This notation is entered in the "Remarks" column of parts list and indicates parts position in the technical manual.

2-A3 → Parts position. The technical manual is divided into 16 equal sections. Each section can be identified by using A, B, C and D from left to right and 1, 2, 3 and 4 from top to bottom.

→ Indicates page number in which the technical manual appears. However, 1/1 (page 1 of 1) is not indicated particularly.

PARTS LIST

OLYMPUS XA

LEE-22 1/6

<u>PARTS NO.</u>	<u>NAME OF PARTS</u>	<u>NOTE</u>	<u>(Q'ty used/ per unit</u>
CA752900	SPOOL A M	3 - A4	(1)
CA796300	E RING M	4 - C1	(1)
CA840400	SCREW	2 - C1	(1)
CA845700	SHAFT	4 - C4	(2)
CA846300	E RING	4 - B2	(1)
CA873000	PIN	1 - C1	(1)
CA873500	SPRING	2 - C1	(1)
CA911200	SHAFT	3 - A3	(1)
CE112200	SHEET	3 - B4	(1)
CE300500	FRONT COVER	1 - D2	(1)
CE300700	NO. PLATE	1 - A3	(1)
CE301000	P RUBBER	1 - A2	(1)
CE301600	KEY MOLT	1 - C2	(1)
CE301700	SHAFT	1 - A3	(1)
CE301800	HINGE	1 - B3	(1)
CE301900	LIGHT PROOF	1 - A3	(1)
CE302000	SCREW	1 - B3	(4)
CE302100	SELF LEVER	1 - B4	(1)
CE302200	SELF SHAFT	3 - A4	(1)
CE302600	SELF CONTACT	3 - A4	(1)
CE302800	SELF NN	3 - A4	(1)
CE303000	SELF CLICK	1 - B4	(1)
CE304000	REAR MOLT	1 - A2	(1)
CE304100	SHEET	1 - C2	(1)
CE304200	P COVER	1 - B1	(1)
CE304500	BATTERY LID	1 - B4	(1)
CE304800	B SPRING	3 - C4	(1)
CE305000	M KEY	2 - C2	(1)
CE305100	M KEY COVER	2 - C3	(1)
CE305200	M KEY SPRING 1	2 - C1	(1)
CE305300	M KEY SPRING 2	2 - C3	(1)
CE306300	AS NUT	3 - B3	(1)
CE306600	LEATHER L	2 - C3	(1)
CE306800	LIGHT PROOF L	1 - C2	(1)
CE306900	LIGHT PROOF R	1 - B4	(1)
CE307000	LIGHT PROOF L	1 - C3	(1)
CE307100	L MOLT	4 - A2	(1)
CE307200	FN SHEET	1 - C3, 1 - D4	(2)
CE307300	LIGHT PROOF	1 - B3	(2)
CE307700	SHAFT	4 - C2	(1)
CE308200	SPRING	4 - C2	(1)
CE308500	PLATE	4 - C2	(1)
CE308700	SPRING 2	4 - C2	(1)
CE309000	K SWITCH	4 - C2	(1)
CE309700	K ROLLER	1 - B1	(1)
CE309800	K CLICK	1 - C2	(1)
CE309900	K NUT	1 - C2	(1)
CE310000	SPOOL HOLDER	3 - A2	(2)
CE310100	KNOB	2 - A3	(1)
CE310700	S ROLLER	3 - A1	(1)
CE310800	S UPPER HOLDER	3 - A2	(1)
CE310900	S SHAFT	3 - A2	(1)

PARTS LIST

OLYMPUS XA

LEE-22 2/6

<u>PARTS NO.</u>	<u>NAME OF PARTS</u>	<u>NOTE</u>	(Q'ty used/ per unit)
CE311000	S SHAFT STOPPER	3 - A1, 3 - A4	(2)
CE311100	S LOWER HOLDER	3 - A4	(1)
CE311200	S GEAR	3 - A4	(1)
CE311500	SPRING	3 - A1	(1)
CE311700	WASHER	3 - A2	(1)
CE311800	S SPRING	3 - A2	(1)
CE312000	SP HOLDER	2 - C4	(1)
CE312100	SP SHAFT	2 - C4	(1)
CE312300	SP SPRING 1	2 - C4	(1)
CE312400	U PLATE	2 - B4	(1)
CE312500	SP SPRING 2	2 - C4	(1)
CE312700	SP GEAR 1	2 - C4	(0 ~ 1/5)
CE312800	SP GEAR 2	2 - C4	(0 ~ 1/5)
CE312900	SP GEAR 3	2 - C4	(0 ~ 1/5)
CE313000	SP GEAR 4	2 - C4	(0 ~ 1/5)
CE313100	SP GEAR 5	2 - C4	(0 ~ 1/5)
CE313200	SP SCREW	2 - C3	(1)
CE313300	SLIDER	3 - A3	(1)
CE313500	SPROCKET	2 - C3	(1)
CE313600	SP WASHER	2 - C3	(1)
CE313800	COUNTER GEAR	2 - B2	(1)
CE313900	F.W. COUNTER	2 - B1	(1)
CE314100	COUNTER COVER	1 - A2	(1)
CE314900	CLAW SPRING	2 - B2	(1)
CE315000	CONNECTING SPRING	2 - B2	(1)
CE315100	COUNTER SPRING	2 - B2	(1)
CE315400	COUNTER STOPPER	2 - B2	(1)
CE315500	BUTTON WASHER	2 - B1	(1)
CE316500	U SWITCH	2 - B2	(1)
CE317100	R KNOB WASHER	1 - B1	(1)
CE317200	R FORK	2 - C2	(1)
CE317300	R SHAFT	2 - C2	(1)
CE317600	R SPRING 1	2 - C2	(1)
CE317700	R KNOB	1 - B1	(1)
CE318500	R FORK STOPPER	2 - C1	(1)
CE319100	R LEVER SPRING	1 - B1	(1)
CE319200	DIAPHRAGM BLADE A	4 - D3	(1)
CE319300	DIAPHRAGM BLADE B	4 - D3	(1)
CE319500	FRONT FASTENER	4 - B4	(1)
CE320400	OIL HOLDER	4 - A3	(1)
CE320500	FLOAT PIN	4 - B3	(0 ~ 1/5)
CE320600	FLOAT PIN	4 - B3	(0 ~ 1/5)
CE320700	FLOAT PIN	4 - B3	(0 ~ 1/5)
CE320800	FLOAT PIN	4 - B3	(0 ~ 1/5)
CE320900	FLOAT PIN	4 - B3	(0 ~ 1/5)
CE321600	REAR FASTENER	4 - A2	(1)
CE322700	ASA CLICK	4 - B4	(1)
CE323200	FN PLATE 1	1 - C3	(1)
CE323800	FN CLICK	4 - B3	(1)
CE323900	FN SPRING	4 - B3	(1)
CE324100	FOCUSING LEVER	4 - A3	(1)
CE324200	FLOAT SPRING	4 - A3	(1)
CE324500	NAME PALTE	4 - B4	(1)
CE324600	FC WASHER	4 - D1	(0 ~ 4/6)

PARTS LIST

OLYMPUS XA

LEE-22 3/6

<u>PARTS NO.</u>	<u>NAME OF PARTS</u>	<u>NOTE</u>	(Q'ty used/ per unit)
CE324900	FC WASHER 03	4 - D1	(0 ~ 8/6)
CE325700	AS SHAFT 1	2 - C1	(1)
CE326000	AS COLLAR	2 - C1, 4 - C2	(3)
CE326100	AS SPRING	2 - C1	(1)
CE326600	FASTENER	4 - D4	(1)
CE326800	MOLT	4 - A3	(1)
CE331300	AD SCREW	3 - C2	(1)
CE332200	OB FRAME	3 - C1	(1)
CE332400	F UPPER COVER	3 - C1	(1)
CE332600	FOCUSING PIN 1	3 - C3	(0 ~ 1/4)
CE332700	FOCUSING PIN 2	3 - C3	(0 ~ 1/4)
CE332800	FOCUSING PIN 3	3 - C3	(0 ~ 1/4)
CE332900	FOCUSING PIN 4	3 - C3	(0 ~ 1/4)
CE333200	HOLE COVER	3 - B3	(1)
CE333500	WASHER 11	3 - C2	(0 ~ 1/2)
CE333600	WASHER 12	3 - C2	(0 ~ 1/2)
CE334600	GEAR WASHER	2 - C4	(1)
CE335000	SP CLAW SPRING	4 - C2	(1)
CE335300	WASHER	4 - B1	(3)
CE335400	FS CONTACT	4 - C1	(1)
CE335500	FS LEVER	4 - C1	(1)
CE335700	RELEASE RUBBER	2 - B1	(1)
CE335900	C BASE WASHER	4 - B1	(1)
CE336300	WIRE STOPPER	4 - C1	(1)
CE336400	BUZZER	1 - C2	(1)
CE336800	BUTTON	1 - B1	(1)
CE336900	BUTTON WASHER 1	2 - B1	(0 ~ 1/5)
CE337000	BUTTON WASHER 2	2 - B1	(0 ~ 1/5)
CE337100	BUTTON WASHER 3	2 - B1	(0 ~ 1/5)
CE337200	BUTTON SPRING	2 - B1	(1)
CE337300	BUTTON COLLAR	2 - B1	(1)
CE337400	BUTTON SCREW	2 - B1	(1)
CE337500	BUTTON CONTACT	2 - B1	(1)
CE337600	BUTTON STOPPER	2 - B1	(1)
CE337700	BUTTON WASHER 4	2 - B1	(0 ~ 1/5)
CE337800	BUTTON WASHER 5	2 - B1	(0 ~ 1/5)
SC0161	MAGNET 1	4 - C2	(1)
SC0162	MAGNET 2	4 - C1	(1)
SC0163	CLAW SPRING	4 - B3	(1)
SC0164	X CONTACT A	4 - C1	(1)
SC0165	CONTACT BASE	4 - B3, 4 - C1	(2)
SC0166	X CONTACT B	4 - C1	(1)
SC0167	INSULATION WASHER	4 - C1, 4 - C3	(2)
SC0168	SCREW	4 - C1, 4 - C3	(2)
SC0170	C CONTACT A	4 - B3	(1)
SC0172	C CONTACT B	4 - B3	(1)
SC0175	DIAPHRAGM FASTENER	4 - C3	(2)
SC0176	SHUTTER BLADE	4 - C3	(2)
SC0177	F SPRING	4 - C3	(1)
SC0178	BLADE FASTENER	4 - C3	(1)
SC0179	KT NUT	4 - D1	(1)
SC0180	SET SPRING	4 - D1	(1)

<u>PARTS NO.</u>	<u>NAME OF PARTS</u>	<u>NOTE</u>	<u>(Q'ty used/ per unit)</u>
ZK735000	R BUTTON ASS'Y	2 - C4	(1)
ZK735200	S UPPER PLATE ASS'Y	3 - A1	(1)
ZK735300	S PLATE ASS'Y	3 - A1	(1)
ZK735500	SELF BASE PLATE ASS'Y	3 - A4	(1)
ZK735600	B CONTACT 1 ASS'Y	3 - C3	(1)
ZK735800	AS BOARD ASS'Y	3 - D3	(1)
ZK735900	AS SCREW ASS'Y	3 - D3	(1)
ZK736100	P. UPPER PLATE ASS'Y	2 - C2	(1)
ZK736300	B CONTACT 2 ASS'Y	3 - C4	(1)
ZK736400	METER BASE ASS'Y	3 - B2	(1)
ZK736600	PRESSURE PLATE ASS'Y	1 - A2	(1)
ZK736900	R LEVER ASS'Y	1 - C1	(1)
ZK737000	ASA PLATE ASS'Y	4 - D4	(1)
ZK737100	SP CLAW ASS'Y	4 - C2	(1)
ZK737200	AS LEVER 1 ASS'Y	2 - C1	(0 ~ 1/3)
ZK737600	BODY ASS'Y	1 - C3	(1)
ZK738000	F BODY ASS'Y	3 - C1	(1)
ZK738300	F.W. BASE ASS'Y	2 - A3	(1)
ZK738400	FRONT PLATE ASS'Y	1 - D3	(1)
ZK738500	TOP COVER ASS'Y	1 - A2	(1)
ZK738600	BOTTOM PLATE ASS'Y	1 - B4	(1)
ZK738800	AMP. BOARD ASS'Y	4 - A1	(1)
ZK738900	SHUTTER ASS'Y	4 - A2	(1)
ZK739000	LEVER ASS'Y	4 - A2	(1)
ZK739100	FN PLATE ASS'Y	4 - C4	(1)
ZK739200	ASA RING ASS'Y	4 - D4	(1)
ZK739300	FOCUSING RING M ASS'Y	4 - A3	(0 ~ 1/2)
ZK739400	LENS HOUSING ASS'Y	4 - B3	(1)
ZK739700	FN LEVER ASS'Y	4 - C4	(1)
ZK739800	FOCUSING RING F ASS'Y	4 - A3	(0 ~ 1/2)
ZK739900	AS LEVER 2 ASS'Y	2 - C1	(0 ~ 1/3)
ZK740000	AS LEVER 3 ASS'Y	2 - C1	(0 ~ 1/3)
ZJ138100	REAR COVER ASS'Y	1 - A2	(1)
DS4002	EXPOSURE METER	3 - C1	(1)
ES5011	CdS CELL FOR SHUTTER	4 - C4	(1)
ES5012	LED	4 - B3	(1)
ES5013	CdS CELL FOR METER	4 - D4	(1)
LC409800	COVER GLASS	1 - B2	(1)
LC410400	OBJECT LENS	3 - C1	(1)
LC410500	M LENS	3 - C1	(1)
LC410800	EYE PIECE LENS	3 - C1	(1)
RS0048	RESISTOR	10.0K Ω 1/8W R202, 203	
RS0135	RESISTOR	10.2K Ω 1/8W R201	
RS0136	RESISTOR	10.7K Ω 1/8W R201	
RS0137	RESISTOR	11.3K Ω 1/8W R201	

59

<u>PARTS NO.</u>	<u>NAME OF PARTS</u>	<u>NOTE</u>	(Q'ty used/ per unit)
RS0138	RESISTOR	11.8K Ω 1/8W R201	
RS0139	RESISTOR	12.4K Ω 1/8W R201	
RS0140	RESISTOR	13.0K Ω 1/8W R201, 203	
RS0141	RESISTOR	13.7K Ω 1/8W R201	
RS0142	RESISTOR	8.2K Ω 1/8W R202	
RS0143	RESISTOR	8.66K Ω 1/8W R202	
RS0144	RESISTOR	9.1K Ω 1/8W R202	
RS0145	RESISTOR	11.0K Ω 1/8W R202, 203	
RS0146	RESISTOR	12.0K Ω 1/8W R202, 203	
RS0147	RESISTOR	14.0K Ω 1/8W R201, 202	
RS0148	RESISTOR	15.0K Ω 1/8W R202, 203	
RS0149	RESISTOR	16.0K Ω 1/8W R202	
RS0150	RESISTOR	18.0K Ω 1/8W R202, 203	
RS0151	RESISTOR	20.0K Ω 1/8W R202	
RS0152	RESISTOR	22.0K Ω 1/8W R202	
RS0153	RESISTOR	24.0K Ω 1/8W R202	
RS0154	RESISTOR	27.0K Ω 1/8W R202	
RS0155	RESISTOR	30.0K Ω 1/8W R202	
RS0156	RESISTOR	33.0K Ω 1/8W R202	
RS0157	RESISTOR	39.0K Ω 1/8W R202	
RS0158	RESISTOR	47.0K Ω 1/8W R202	
RS0159	RESISTOR	56.0K Ω 1/8W R202	
RS0160	RESISTOR	68.0K Ω 1/8W R202	
RS0161	RESISTOR	91.0K Ω 1/8W R202	
RS0162	RESISTOR	120K 1/8W R202	
RS0163	RESISTOR	220K Ω 1/8W R202	
RS0164	RESISTOR	6.8K Ω 1/8W R203	
RS0165	RESISTOR	7.5K Ω 1/8W R203	
RS0166	RESISTOR	9.1K Ω 1/8W R203	
RS0167	RESISTOR	10.5K Ω 1/8W R201	
RS0168	RESISTOR	11.0K Ω 1/8W R201	
RS0169	RESISTOR	11.5K Ω 1/8W R201	
RS0170	RESISTOR	12.1K Ω 1/8W R201	
RS0171	RESISTOR	12.7K Ω 1/8W R201	
RS0172	RESISTOR	13.3K Ω 1/8W R201	
RS0173	RESISTOR	13.0K Ω 1/8W R202	
RS0176	RESISTOR	14.3K Ω 1/8W R201	
RS0177	RESISTOR	14.7K Ω 1/8W R201	
RS0178	RESISTOR	15.0K Ω 1/8W R201	
RS0179	RESISTOR	15.4K Ω 1/8W R201	
RS0180	RESISTOR	4.3K Ω 1/8W R202	
RS0181	RESISTOR	4.7K Ω 1/8W R202	
RS0182	RESISTOR	5.1K Ω 1/8W R202	
RS0183	RESISTOR	5.6K Ω 1/8W R202	
RS0184	RESISTOR	6.2K Ω 1/8W R202	

RBJ-A	LEAD WIRE BLUE	Length: 10m
RBJ-B	LEAD WIRE BLACK	Length: 10m
RBJ-C	LEAD WIRE BROWN	Length: 10m
RBJ-D	LEAD WIRE ORANGE	Length: 10m
RBJ-P	LEAD WIRE PINK	Length: 10m
RBJ-R	LEAD WIRE RED	Length: 10m
RBJ-W	LEAD WIRE WHITE	Length: 10m

PARTS LIST

OLYMPUS XA

LEE-22 6/6

<u>PARTS NO.</u>	<u>NAME OF PARTS</u>	<u>NOTE</u>	(Q'ty used/ per unit)
RBJ-Y	LEAD WIRE YELLOW	Length: 10m	
RAJ-B	LEAD WIRE BLACK	Length: 10m	
TNJ-N	TUBE WHITE	Length: 5m	
PUK1.4 x 1.2SN	SCREW		
PUK1.4 x 2.5SN	SCREW		
PUK1.4 x 4SN	SCREW		
PUK1.4 - 204SN	SCREW		
PUK1.4 - 606SN	SCREW		
PUK1.4 - 608SN	SCREW		
PUK1.6 x 2.5SN	SCREW		
PUK1.6 - 513SN	SCREW		
PUK1.6 - 608SN	SCREW		
PUK1.7 x 2.8SN	SCREW		
PUK1.7 x 3.5SN	SCREW		
PUK2 x 2.2SN	SCREW		
PUK2 x 2.2SB	SCREW		
PUK2 - 208SH	SCREW		
3PUK1.4 x 3.5SN	SCREW		
3PUK1.4 x 4SN	SCREW		
PSK2 x 4SN	SCREW		
PUTB2 x 2.2SN	SCREW		
PUTB2 x 2.5SN	SCREW		
PUTB2 x 2.5SB	SCREW		
PUTB2 x 3SN	SCREW		
PUTB2 x 3.5SH	SCREW		
PUTB2 x 3.5SN	SCREW		
PUTB2 x 4SN	SCREW		
PUTB2 x 4SB	SCREW		
PUTB2 x 4.5SH	SCREW		
PUTB2 x 4.5SN	SCREW		
PUTB2 x 6SH	SCREW		
PUTB2 - 306SB	SCREW		
PSTB1.4 x 2SB	SCREW		
PSTB2 x 3SB	SCREW		
PSTB2 x 4.5SN	SCREW		
NW1.4 - 228PO	WASHER		
NW1.5 - 235PO	WASHER		
NW1.5 - 435PO	WASHER		
NW1.6 - 450PO	WASHER		
NW1.7 - 226PO	WASHER		
NW2.1 - 140PO	WASHER		
NW2.1 - 232PB	WASHER		
NW2.1 - 240PO	WASHER		
NW2.1 - 250BC	WASHER		
NW2.1 - 340PO	WASHER		
NW2.1 - 350BO	WASHER		
NW2.1 - 440PO	WASHER		
NW2.1 - 450BO	WASHER		

A | B | C | D

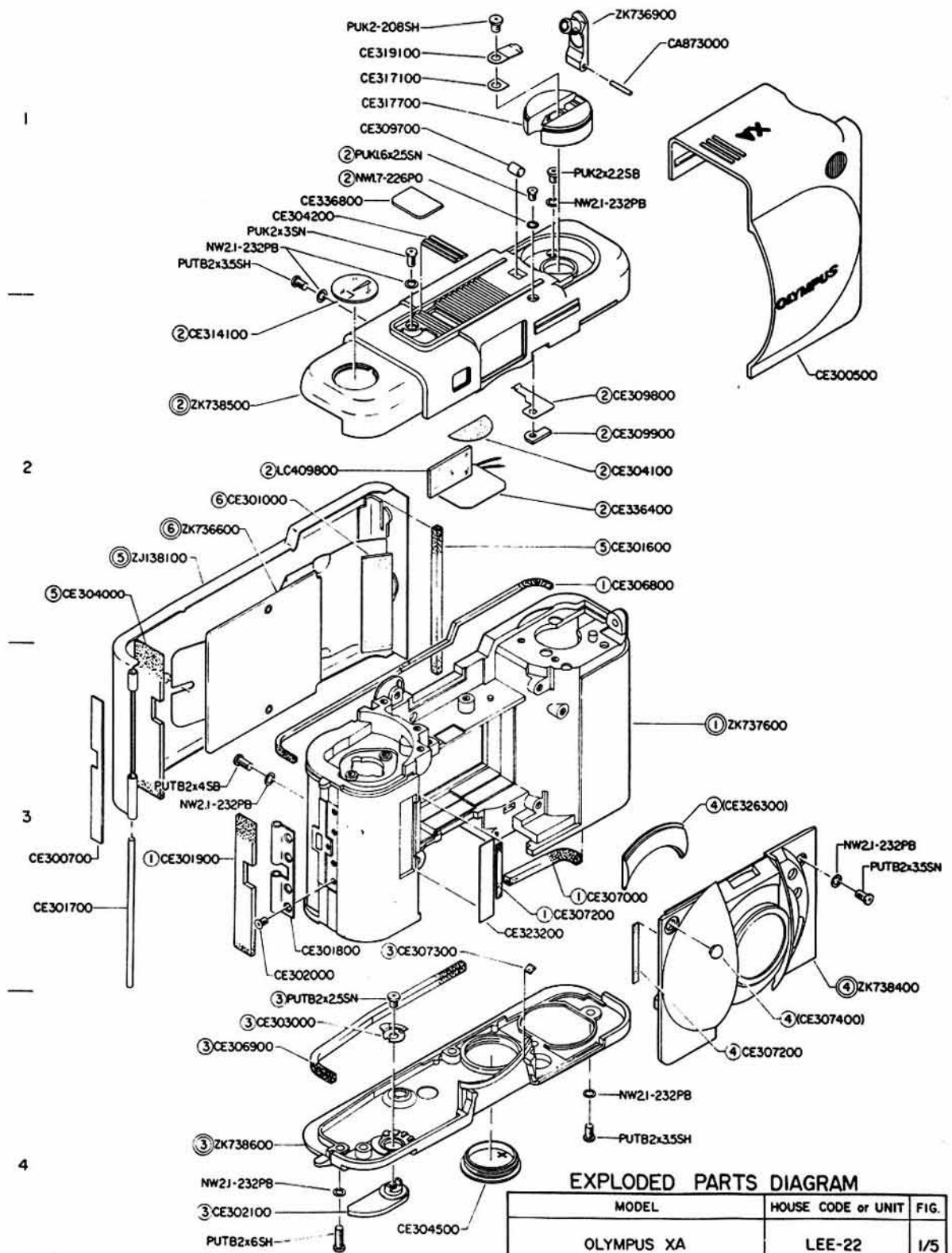

EXPLODED PARTS DIAGRAM

MODEL	HOUSE CODE or UNIT	FIG.
OLYMPUS XA	LEE-22	1/5

NOTE: WHEN ORDERING FOR SPARE PARTS, PLEASE CLARIFY A MODEL or HOUSE CODE, PARTS NUMBER AND QUANTITY.

8

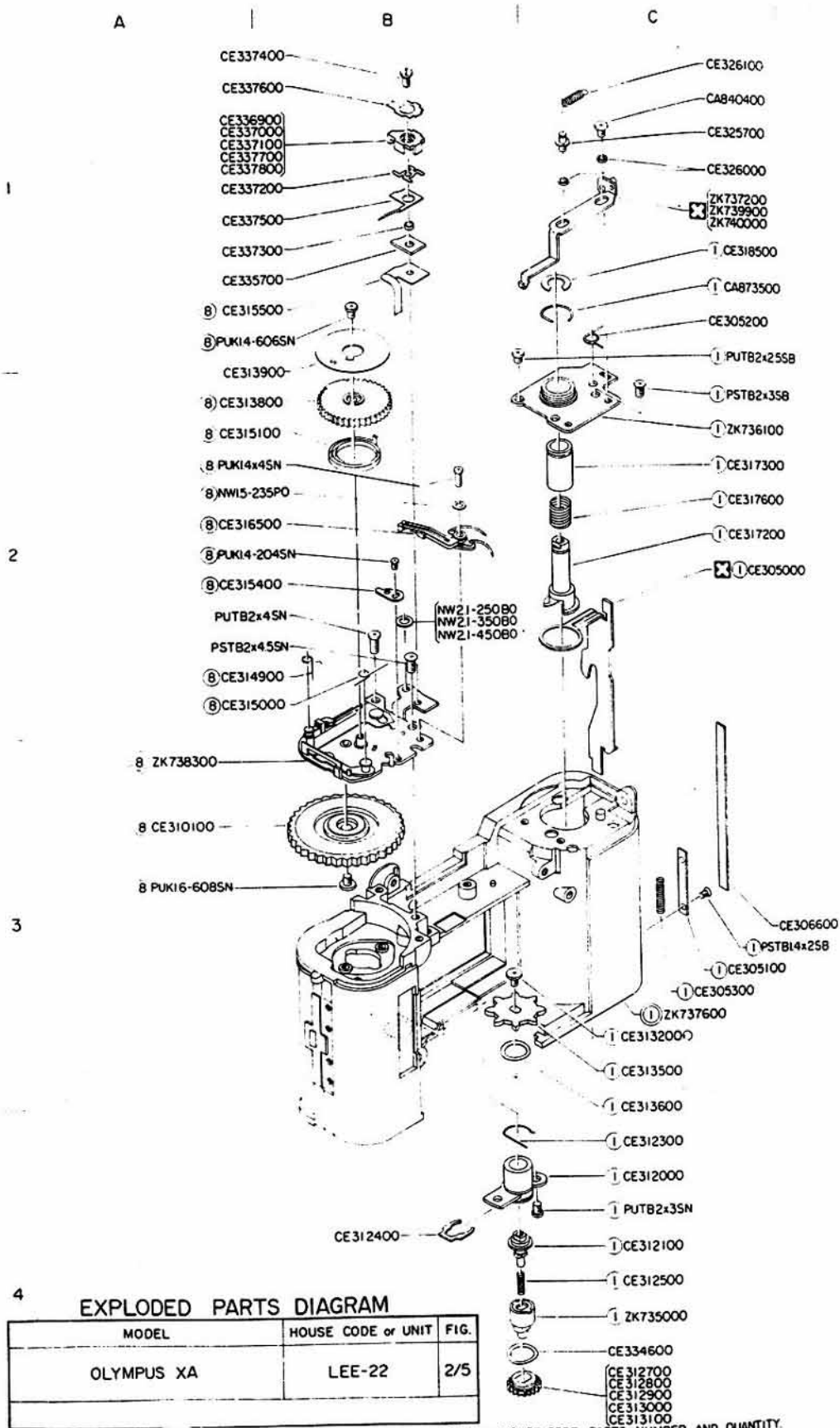

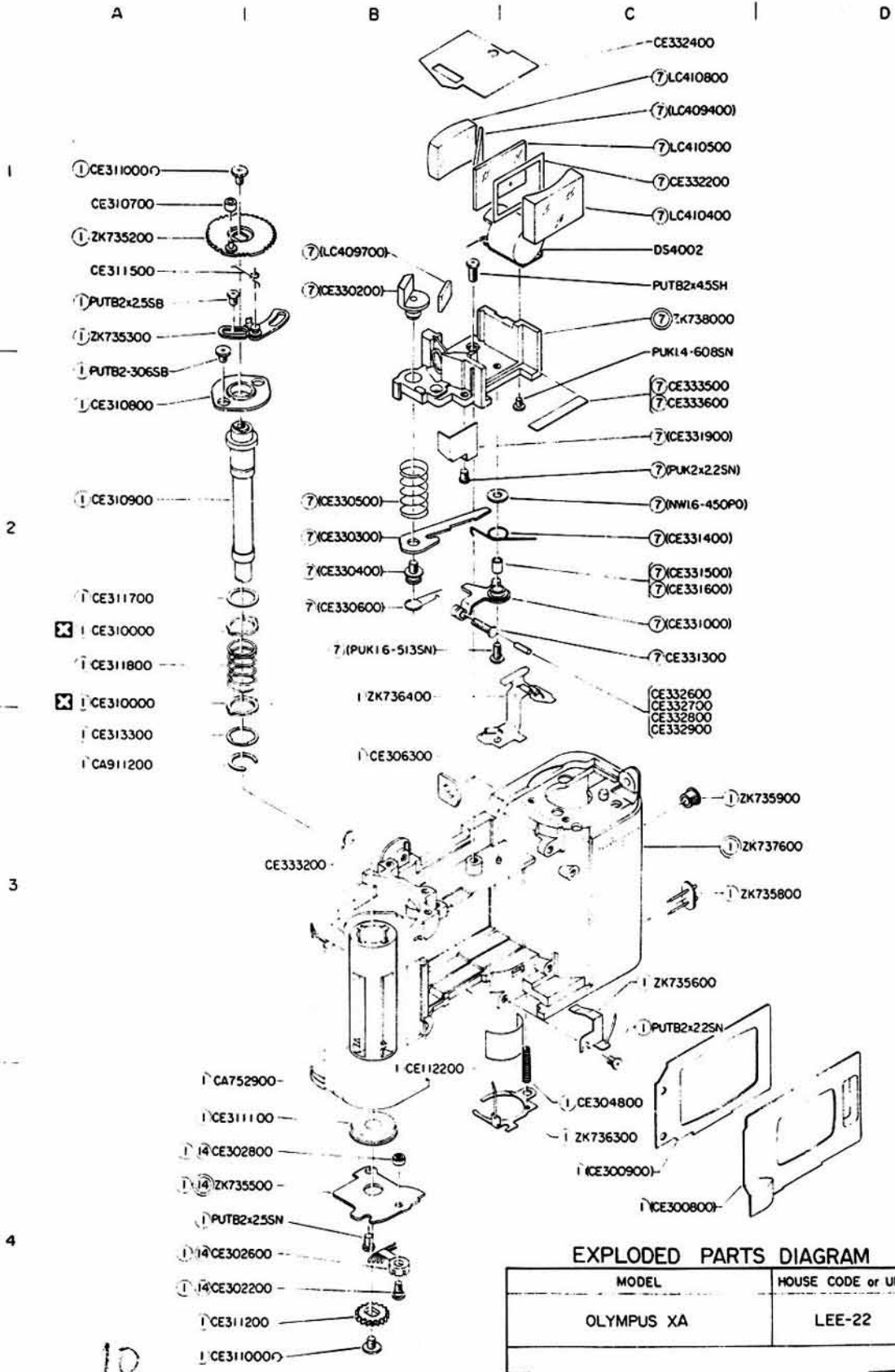

EXPLODED PARTS DIAGRAM

MODEL	HOUSE CODE or UNIT	FIG.
OLYMPUS XA	LEE-22	3/5

NOTE: WHEN ORDERING FOR SPARE PARTS, PLEASE CLARIFY A MODEL or HOUSE CODE, PARTS NUMBER AND QUANTITY.

10

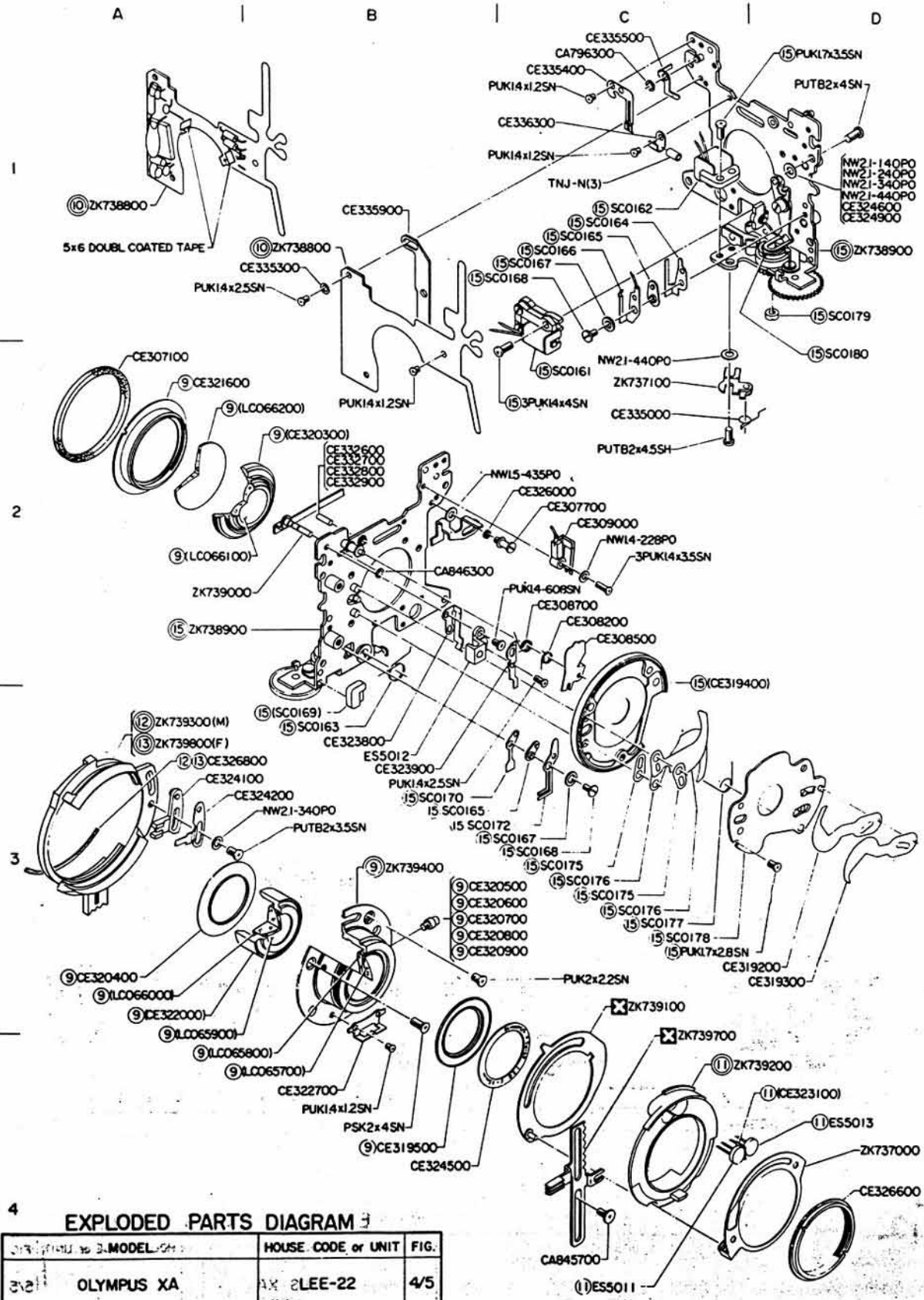

EXPLODED PARTS DIAGRAM

MODEL	HOUSE CODE or UNIT	FIG.
OLYMPUS XA	AX 2LEE-22	4/5

NOTE: WHEN ORDERING FOR SPARE PARTS, PLEASE CLARIFY A MODEL or HOUSE CODE, PARTS NUMBER AND QUANTITY.

A | B | C | D

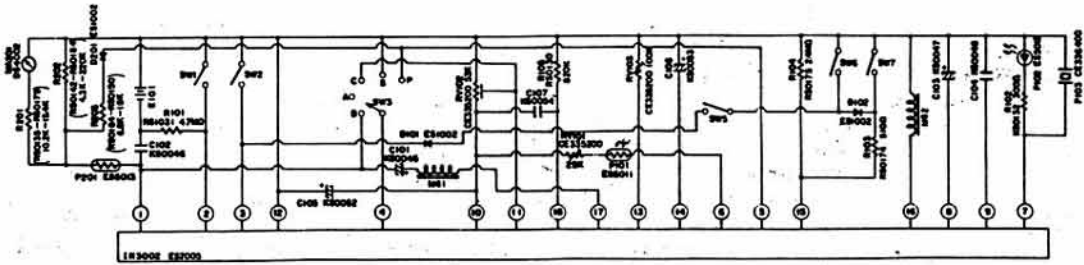
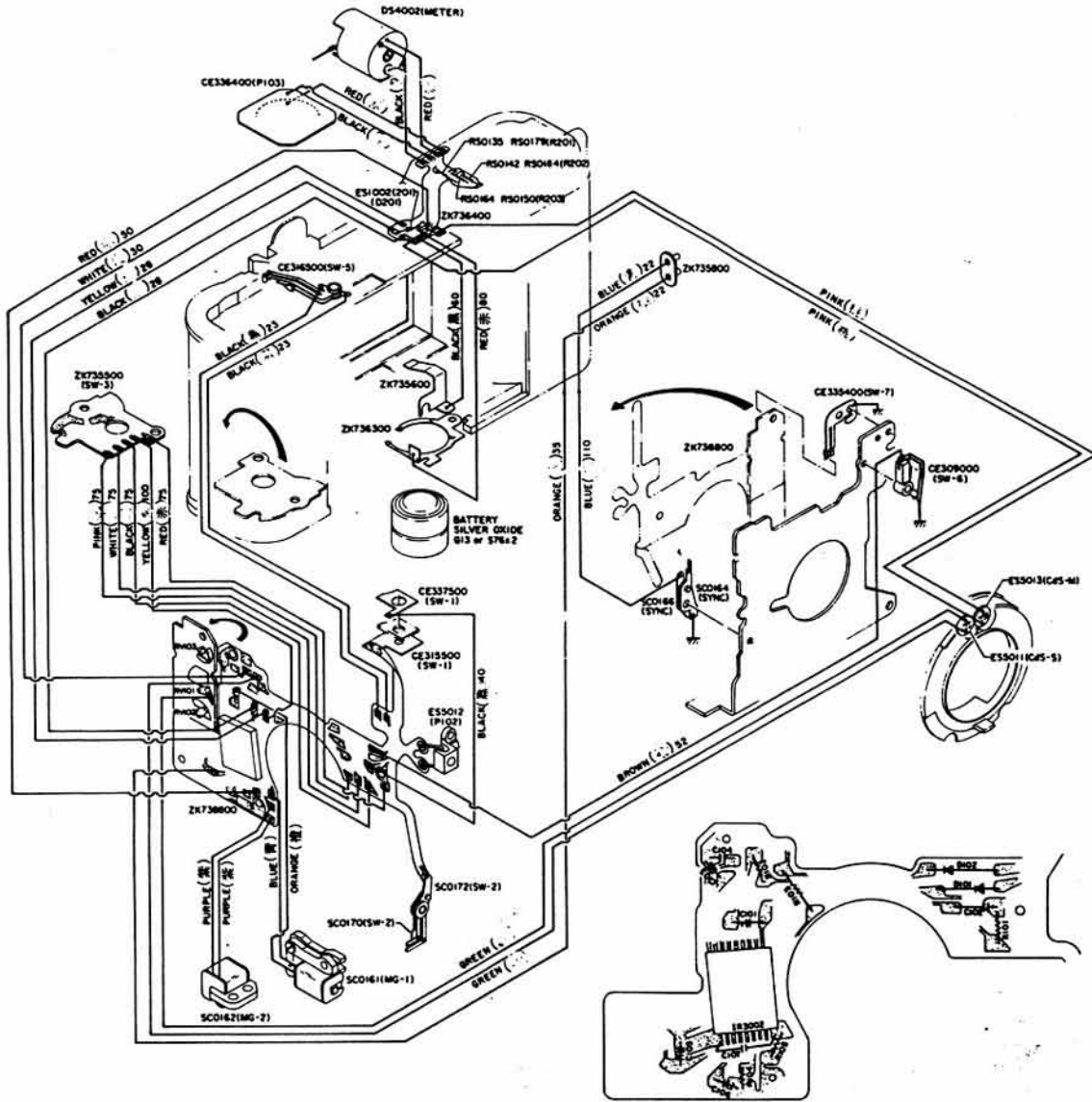

EXPLODED PARTS DIAGRAM 3

MODEL	HOUSE CODE or UNIT	FIG.
OLYMPUS XA	AX (LEE-22)	5/5
AND		

NOTE: WHEN ORDERING FOR SPARE PARTS, PLEASE CLARIFY A MODEL FOR HOUSE CODE, PARTS NUMBER AND QUANTITY.

12

A. GENERAL OUTLINE AND MECHANICAL FEATURES

MAIN SPECIFICATIONS

Model Name: OLYMPUS XA

House Code: LEE-22

Type:

35 mm lens shutter camera.

Frame size:

24 x 36, 35 mm

Lens:

F Zuiko, F2.8, f = 35 mm, 6 elements in 5 groups.

Shutter:

Electronic between-lens shutter.

Viewfinder:

Inverted Galilean type Albada finder of 0.55 magnifications with shutter speed indicator and improper exposure warning inside.

Focusing:

Focusing with coincidence rangefinder to the range of $\infty \sim 0.85$ m.

Exposure control:

Automatic exposure control with electronic shutter of prior aperture selection type; Automatically controlled shutter speed range: 10 ~ 1/500 sec.; Backlight correction with mode selector at +1.5 EV.

Film speed range:

ASA 25 ~ 800

Aperture range:

F2.8 ~ F22

Film winding:

Rear winding up to an angle of 360°.

Frame counter:

Sequential counting type with automatic restoration device.

Film rewinding:

Rewinding with crank.

Shutter release:

Electromagnetic release.

Self-timer:

Electronic self-timer to provide 12 sec. delay while blinking LED synchronously with the sounding of electronic beeper.

Flash mounting:

Exclusive automatic Electronic Flash A11 attaches to (or detaches from) the camera in seconds.

Flash control:

Automatic control by Electronic Flash A11.

Lens/finder barrier:

Sliding type

Power source:

Two 1.5-volt silver oxide cells (JIS G13).

Size:

102 (W) x 64 (H) x 39.5 (D) mm

Weight:

225 g (less batteries)

WARNINGS

1. Ground the camera body when removing the shutter assembly to repair the circuit board; otherwise the integrated circuit may be damaged.
2. Since many parts are made of plastic material, caution must be exercised not to ruin screw threads when tightening PUTB and PSTB. Prior to screwing, turn the screw a little counterclockwise in the female fitting so as to enable the screw thread to click in the groove of the female fitting. Then, tighten the screw. When the screw thread is damaged, use a longer or thicker screw, or inject Araldite into the female fitting to fix the screw in place. Do not use Lock Tight or it may develop cracks.
3. When cleaning the external part, use clean cloth or cloth impregnated with a mixed solution. Do not rub hard. Solvents such as MEK (Methyl Ethyl Ketene) must not be used for the cleaning, since they dissolve plastic material.
4. Do not use any greases or adhesives other than those specified; otherwise, the camera performance may be deteriorated.

14

CIRCUITRY

The circuitry is composed of the hold circuit, mode selector circuit, battery check circuit, delay circuit, integral circuit, comparator, oscillation circuit and meter circuit.

1. Hold circuit

The hold circuit will start working by turning on SW1 if a minimum start-up voltage of 2.2 ± 0.05 V is detected by completion of film exposure. When the start-up voltage is less than 2.2 ± 0.05 V, the hold circuit does not function. Electric current, therefore, will not flow into MG1 even if SW1 is turned on and the diaphragm blades will not open.

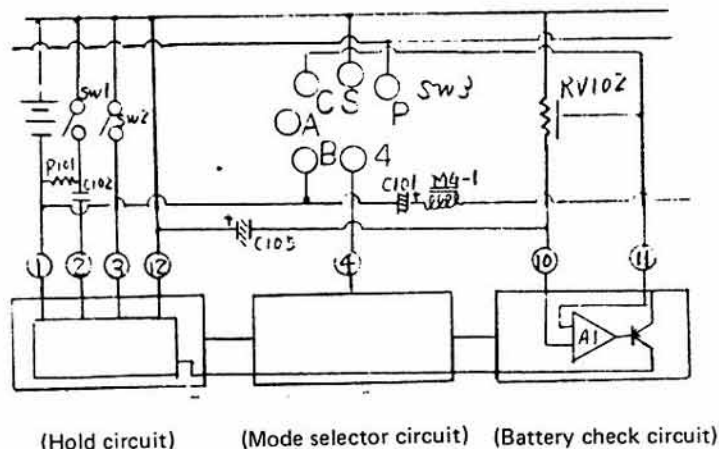

2. Mode selector circuit

The mode selector circuit is designed to select 4 different modes, viz, self-timing, battery check, automatic shutter speed and ± 1.5 EV correction.

Self-timing mode

With SW3 being turned to (S), (4) is connected to (S) (plus) and with SW1 being turned on, the delay circuit starts functioning (time-setting circuit of R105 and C107). In ca. 12 seconds, MG1 is turned on to activate the diaphragm blades. The oscillation circuit functions during this short period of ca. 12 seconds to emit a 2.4 KHz beep at the intervals of 2 Hz synchronously with the blinking of LED.

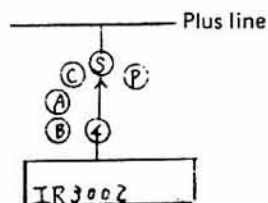

Release of self-timing mechanism

With SW3 being switched to (C), (S) is connected to C (11 is connected to +) and the self-timing mechanism is released. Although the release position is not indicated on the camera body, the release switch is turned on while SW3 is being switched to CHECK, thereby causing the self-timing mechanism to be released. (4 is connected to C while the former remains connected with (S).)

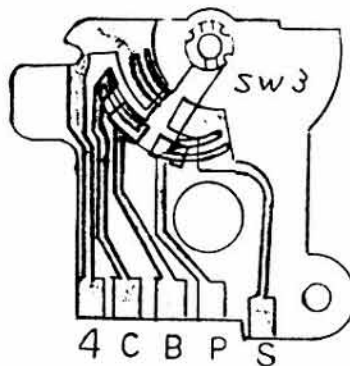

Auto shutter speed mode

④ is turned off by switching SW3 to (A), thereby giving operational priority to the setting of apertures when the aperture selector knob is set in the range of F2.8 to F22 or to the setting of high shutter speeds of 1/500 to 1/30 (by low speed limiter) when the knob is set at FLASH.

Battery check mode

④ is connected to (B) (minus) by switching SW3 to B, thereby activating the battery check circuit. When a minimum start-up voltage of 2.2 ± 0.05 V is applied, the hold circuit starts

functioning and the oscillation circuit is turned on simultaneously to emit a 2.4 KHz beep as well as to blink LED. In case of the voltage less than the minimum, the battery check circuit does not function and neither does the hold circuit. Neither the beep is emitted nor does the LED blink.

+1.5 EV correction mode

(P) is connected to (S) (plus) by switching SW3 to P, thereby causing the current level to change and simultaneously correcting the value indicated by the meter.

SW3 connections

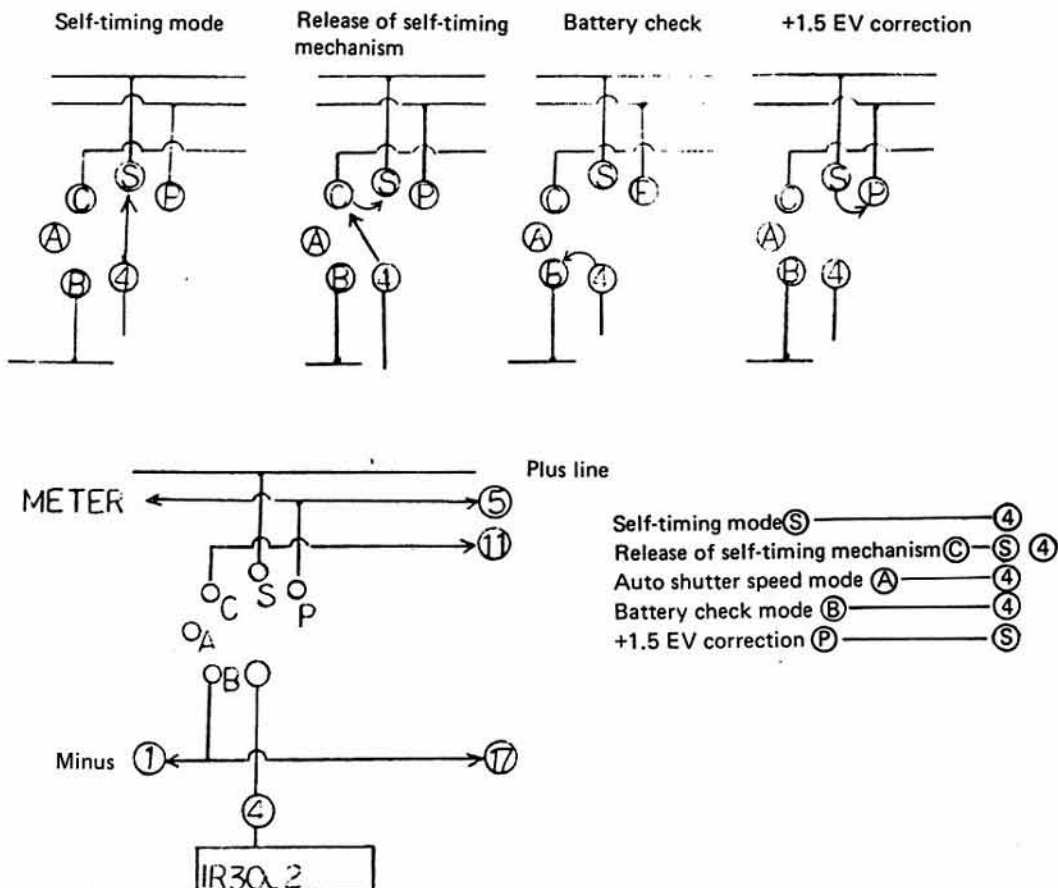

16

3. Battery check circuit

The battery check circuit detects whether the source voltage is 2.2 ± 0.05 V or higher, and if so, it will activate the hold circuit.

When the mode selector is set at:

AutoThe shutter is ready to operate.

B. CHECK.The beeper and LED function.

SELF.The beeper sounds and LED blinks.

When the source voltage is lower, such mechanism does not work.

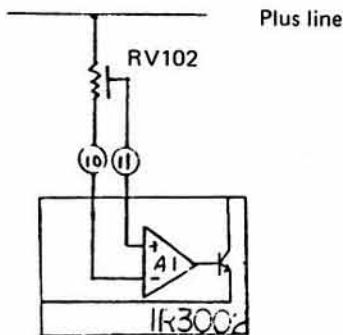

The lock voltage of 2.2 ± 0.05 V is adjusted by RV102.

4. Delay circuit

This circuit is designed to delay the signal to turn on MG1 after turning on SW1. In case the self-timer is used, the signal is delayed by ca. 12 seconds and in other cases, by 16 m sec. The operation of MG2 is stabilized by delaying the signal by a minimum of 16 m sec. thereby enabling correct selection of a shutter speed.

1. Plus line

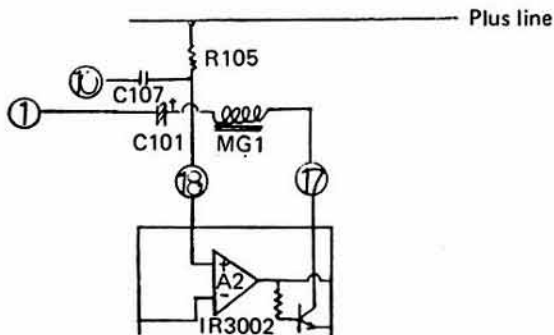

5. Integral circuit and comparator

Simultaneously with the turn-on of MG1, an exposure is determined by CdS, RV101 and integral capacitor C106. When the voltage increases to a given level, the comparator connected to the integral circuit cut the electric flow from MG2.

Although MG2 holds CLAW2 to keep the shutter open, the shutter closes when 16 is turned off.

In the dark, the shutter is not kept open but closed in 10 to 20 seconds by the standard current decided by R104. (Auto limiter)

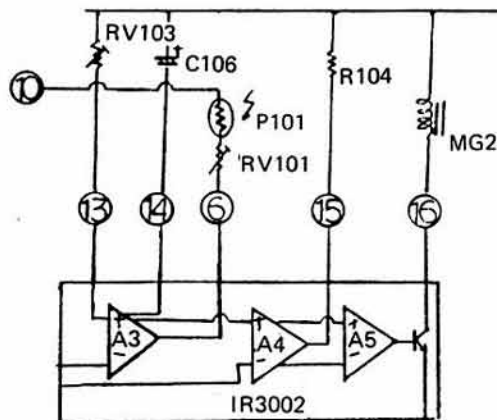

6. Oscillation circuit

This circuit is designed to function at the time of battery check and also when the self-timer is operated. In case of battery check, 2.4 KHz oscillation is produced by A7 and C4 while,

in case of operation of the self-timer, 2 Hz oscillation is produced by A6 and C3 and simultaneously the 2.4 KHz circuit starts working.

Oscillation during battery check

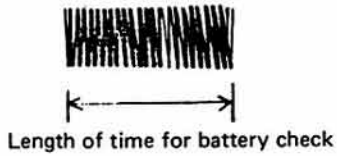

Oscillation during self-timing

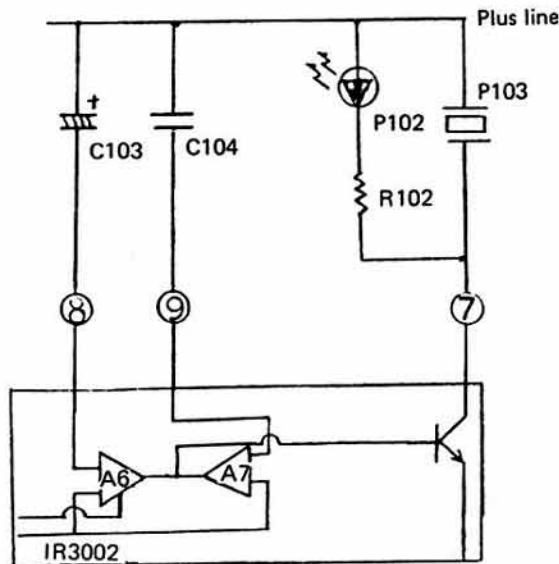
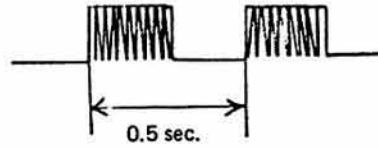

18

OPERATIONS AND THEIR SEQUENCE

When the mode selector is set at AUTO,

1. Close the bottom plate → SW5 will go on.
2. Open the front cover → SW6 will go off.
3. Wind up the film → SW2 will go off.
4. Release the shutter → SW1 will go on.
5. Electric current flows through C102 into ② to activate the hold circuit. The electric current charged to C102 flows from R101 into ① and is discharged by the time-setting circuit to be ready for the following shutter release. (Pulsation system)
6. Will activation of the hold circuit, the delay circuit starts functioning to turn on MG1 in 16 m sec. The 16-m sec. delay is produced by C107 and the 1.5 KΩ time-setting circuit (connected to ⑱) located inside the integrated circuit.
8. At the moment when the hold circuit starts functioning, MG2 goes on and while the shutter is kept open to the fullest extent, CLAW2 is held in place by turning on MG1 and keeps the shutter as is.
9. At the moment when the hold circuit starts functioning and MG1 goes on, the integral circuit also starts working. An exposure is set by CdS and C106. RV103 and RV101 adjust EE level and trigger timing respectively.
10. Once the voltage of C106 is stabilized at a given level by the comparator connected to the integral circuit, electric current is cut off from MG2, which then goes off, thereby causing CLAW2 to come off and the shutter to close. At the same time, the following two operations are performed. The entire mechanism is cleared by turning on SW2. The hold circuit is released by a signal indicating the turn-off of MG2. (Electronic releasing function)

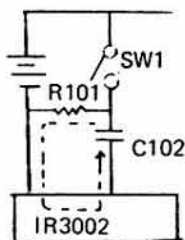

7. MG1, which is a combination magnet, is turned on by discharging the electric energy charged to C101 and loses its attracting power, thereby causing CLAW1 to come off. Although the attracting part of MG1 is given magnetic force by a permanent magnet, once electric current flows into the coil, the magnetic force is lost and MG1 loses power to hold CLAW1 in place.

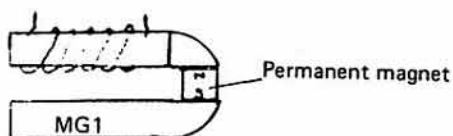
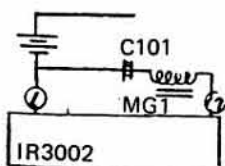

LEE-22 BLOCK DIAGRAM OF OPERATIONS

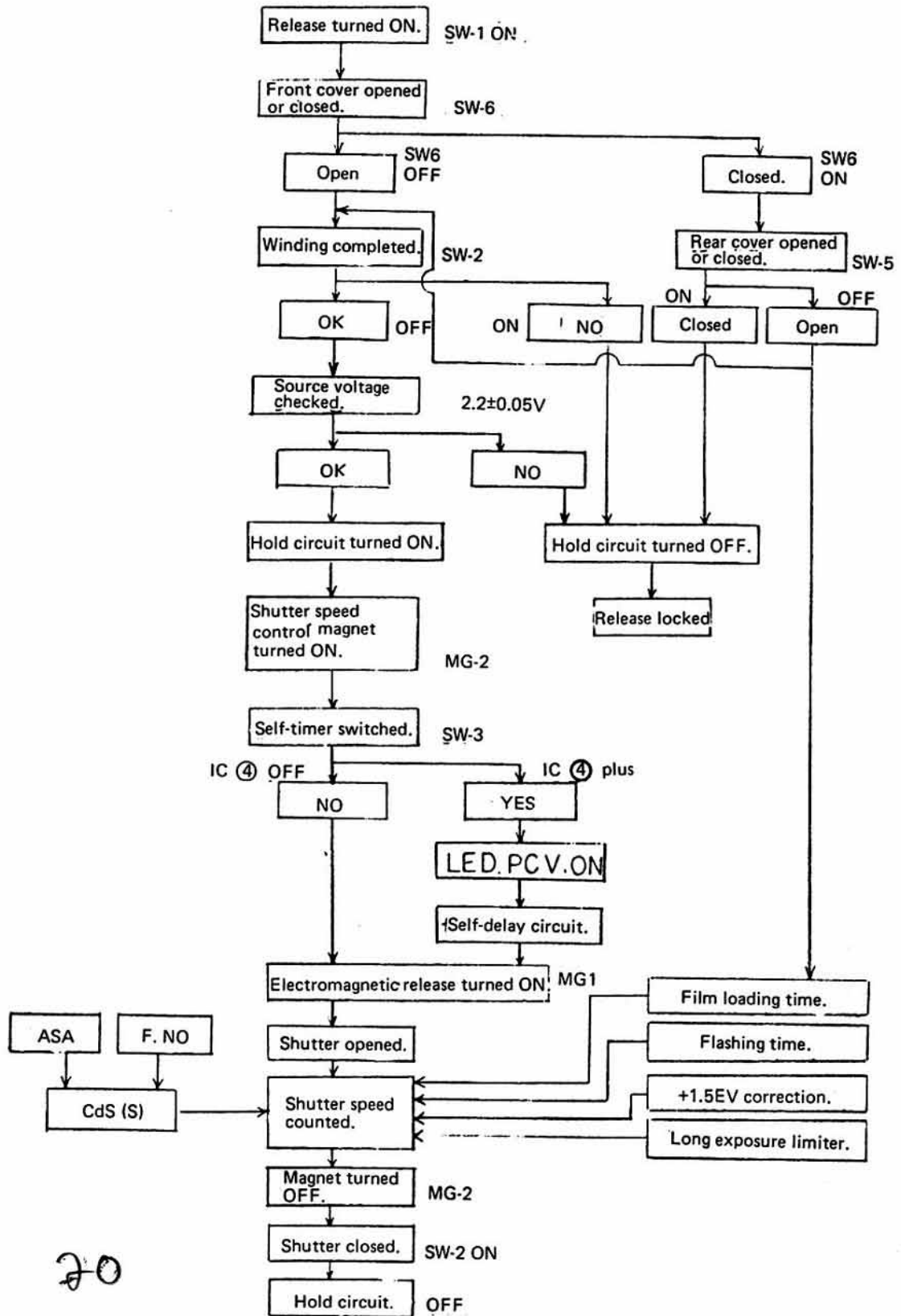

20

LEE-22 CIRCUIT DIAGRAM

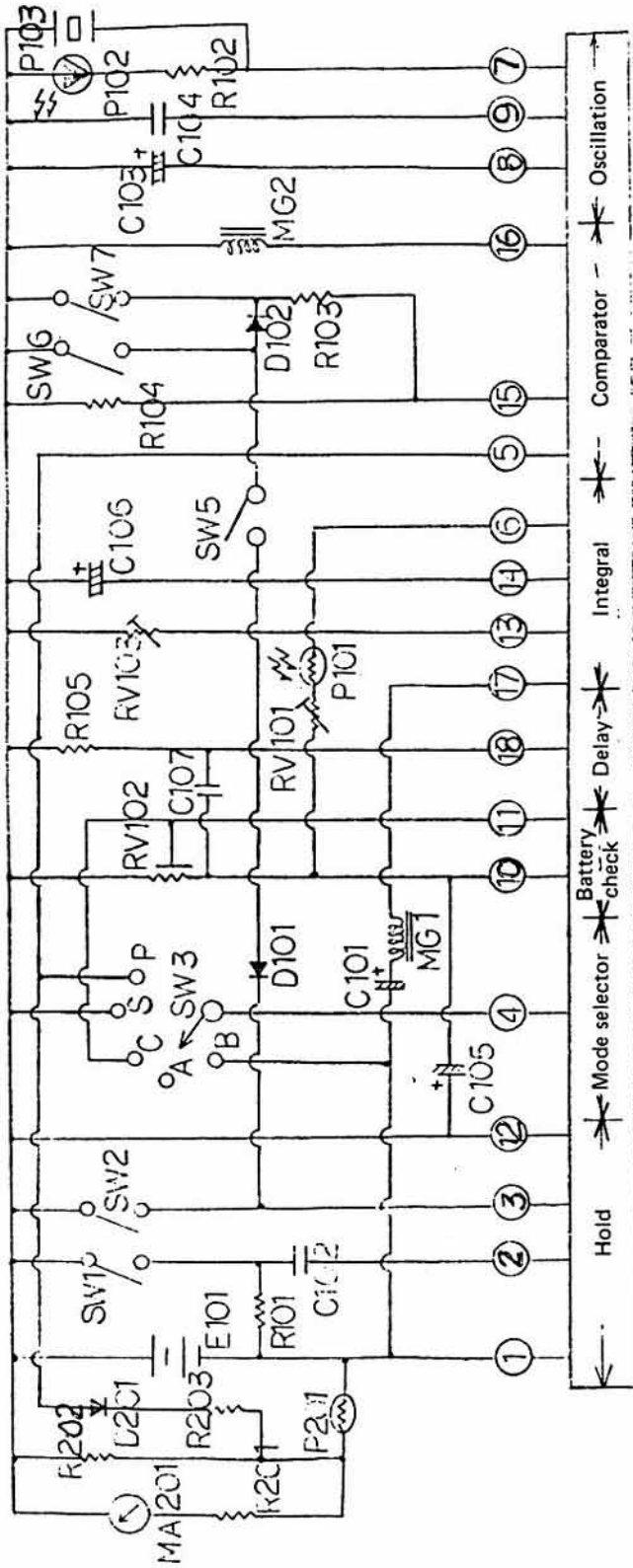

- | | | | |
|--------------|---|--------------|--|
| R101 | For discharge of C102 in preparation for re-releasing of SW1. | RV103 | For adjustment of EE level. |
| R102 | For adjustment of the amount of light for LED. | C101 | For activating MG1. |
| R103 | Paralleled with R104 and used to control flash time. | C102 | For prevention of re-releasing of shutter prior to completion of exposure. |
| R104 | For automatic time limitation to a maximum range of 10 to 20 seconds. | C103 | For 2 Hz oscillation. |
| R105 | For causing delay together with C107. | C104 | For 2.4 KHz oscillation. |
| RV101 | For adjustment of trigger timing. | C105 | For prevention of circuits from oscillation. |
| RV102 | For adjustment of a minimum start-up voltage to activate the battery check circuit. | C106 | Capacitor for integration. |
| | | C107 | For causing delay together with R105. |

SWITCH OPERATIONS

1. SW1 Shutter release switch (Pressure sensing element)

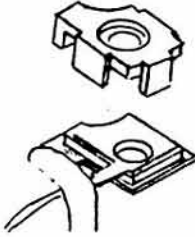

4. SW5 This switch is turned on and off by opening and closing the rear cover.

Open — SW OFF

Close — SW ON



2. SW2 Clear-mechanism switch SW2 goes on when the shutter closes and goes off when the winding is completed. This switch also serves to prevent double exposure. When SW2 is on, the hold circuit does not function.

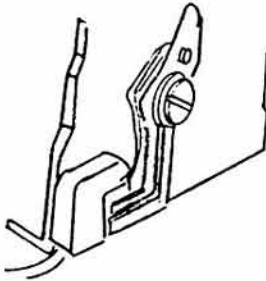

5. SW6 This switch is turned on and off by opening and closing the front cover.

Open — SW OFF

Close — SW ON

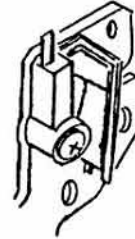

3. SW3 Mode selector switch

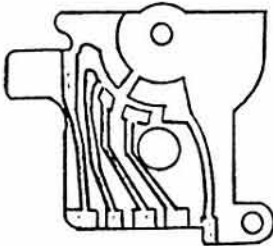

- Ⓢ Self-timer
- Ⓒ Clearmechanism
- Ⓐ Auto
- Ⓑ Battery check
- Ⓟ +1.5 EV

22

6. SW7 Flash switch the switch is connected to ⑮ to set the shutter speed range at 1/500 to 1/30 seconds.



Camera operation by combined use of switches

Front cover SW6	Rear cover SW5	Camera operation	State of camera
Close, ON	Close, ON	Shutter is locked.	When not in use.
Close, ON	Open, OFF	Film loading time 125 ms or less.	When film is being loaded.
Open, OFF	Close, ON	Operation according to mode selection (+1.5EV with SW3 set at P and flashing with SW7 turned ON.)	Photographing and winding after film loading to prepare for photographing.
Open, OFF	Open, OFF	"	At the time of EE check.

PHOTOGRAPHIC LENS

A compact 35 mm camera, LEE-22 is built into a size small enough to be put in a shirt's pocket. Employment of an inner focusing mechanism, the first ever achieved in the world, enables manufacture of such a small-sized camera without deteriorating the performance of a lens, the vital component of the camera.

The inner focusing is a method of focusing by moving an inner lens (floating lens) back and forth

between the front and the rear groups of lenses which are securely fixed in place. Since the focus of an image is determined by the position of the floating lens, it is possible to adjust the focus in a conventional manner. The positioning of the floating lens, however, is a crucial point for focus adjustment since it markedly affects the performance of the camera including the resolving power.

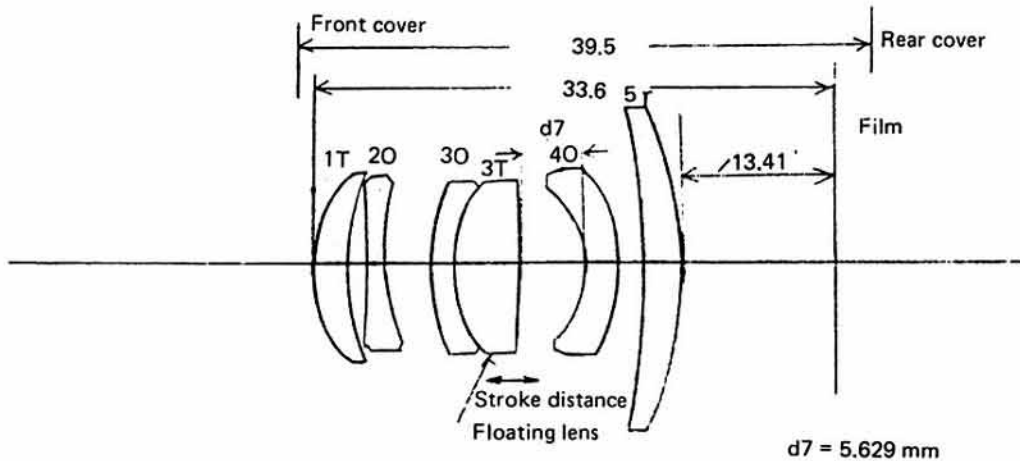

LEE-22 is designed to produce the best resolving power when an image is scaled down to 1/75 (2.6246 m). It is prerequisite to development of the optimum resolving power to set d7 at 5.629 mm when focus is formed at a distance of 2.6246 m. Insert a d7 jig between the floating lens and 4O to make a clearance of 5.629 mm and fix the floating lens securely in place. Read and error with a collimator and insert a washer as thick as an amount of the error between ZK738900 SHUTTER PLATE and the camera body for focus adjustment. Form focus at the said distance by moving the entire lens system back and forth as a whole without changing the clearance between the floating lens and 4O.

24

CONTENTS

I. APPEARANCE AND FUNCTION

1. CE300500 Front cover	B-2
2. CE310100 Knob	B-2
3. CE336800 Button	B-3
4. CE313900 F.W. counter	B-3
5. CE317700 R knob	B-3
6. ZK735000 R button ass'y	B-3
7. ZJ138100 Rear cover ass'y	B-4
8. CE313500 Sprocket	B-4
9. CA752900 Spool AM	B-4
10. ZK737200, ZK739900, ZK740000 AS lever ass'y	B-4
11. CE302100 Self lever	B-5
12. ZK739300, ZK739800 Focusing ring ass'y	B-5
13. ZK739700 FN lever ass'y	B-6
14. ZK739200 ASA ring ass'y	B-6
15. Meter	B-7

II. PERFORMANCE

1. Accuracy of meter indication	B-8
2. Accuracy of meter at the time of changing ASA numbers	B-8
3. Accuracy of plus correction indication	B-8
4. EE accuracy	B-8
5. EE accuracy at the time of changing ASA numbers	B-8
6. EE accuracy at the time of plus correction	B-8
7. Longest exposure time	B-8
8. Shutter speed at the time of flashing	B-8
9. Shutter speed at the time of film loading	B-8
10. Rangefinder accuracy	B-9
11. Power consumption	B-9
12. Power consumption in the dark	B-9
13. X synchronization efficiency	B-9
14. Insulation resistance	B-9
15. X synchronization time lag	B-9

25

B. INSPECTION STANDARDS

I. APPEARANCE AND FUNCTION

Components to be inspected	Related items	Inspection standards
<p>1. CE300500 Front cover</p>		<p>Clicking strength 250 ~ 450 g at the clicking position on the closing side 300 ~ 500 g at the clicking position on the opening side</p>
	<p>(1) CE308500 Plate</p>	<p>CE3058500 Plate must be interlocked with CE300500 Front cover. When CE300500 Front cover is slid open, CE3058500 Plate must not cover even the smallest part of the rangefinder and when the former is closed, the latter must completely cover the rangefinder.</p>
	<p>(2) K switch (SW-6)</p>	<p>The switch must be interlocked with CE300500 Front cover. With ZJ138100 Rear cover ass'y closed, the shutter must be ready to work not when CE300500 Front cover is 1.3 mm or more away in the closing direction from the clicking position on the opening side, but when CE300500 Front cover is at the said clicking position.</p>
<p>2. CE310100 Knob</p>		<p>1) Allowable play of CE310100 Knob CE310100 Knob must not rub hard against ZK 738500 Top cover ass'y or ZK737600 Body ass'y. Allowable play in the direction of turning: Length equivalent to 1/2 the tooth width, or less</p> <p>2) CE310100 Knob must turn smoothly without catching, forcible rubbing, intermittent rubbing, squeaking nor making any unusual sound.</p> <p>3) Winding strength: 130 g max. at the circumference (With no film loaded)</p>

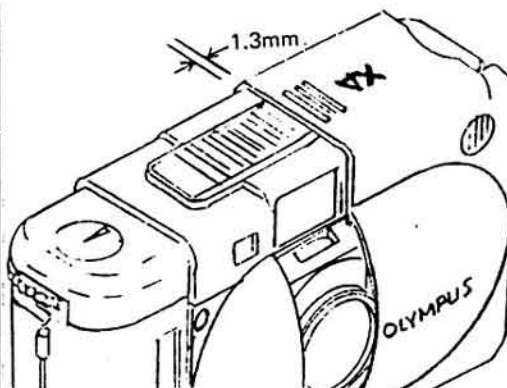

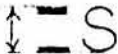
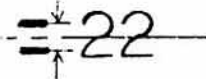
Components to be inspected	Related items	Inspection standards
3. CE336800 Button		1) Depth of depression from Top cover ass'y: 0.25 ± 0.25 mm 2) Shutter releasing strength: 90 g max. at the center of CE336800 Button
4. CE313900 F.W. counter		1) Immediately after closing ZJ138100 Rear cover ass'y, the indicator must remain within the length of symbol "S".  2) In case of the numerical readings of 1 to 36, the indicator must remain within 1/4 the height of each numeral above and below its horizontal center line. 
5. CE317700 R knob		1) The top of CE317700 R knob must not contact CE300500 Front cover when the camera is turned upside down. Clearance of 0.61 ± 0.13 mm must be maintained between them. 2) CE317700 R knob pull strength 1st stage 350 ± 100 g 2nd stage 900 ± 300 g
	(1) CE317200 R fork	Friction of CE317200 R fork 20 ± 10 g
	(2) ZK736900 R lever ass'y	ZK736900 R lever ass'y spring strength: 15 ~ 35 g at the initial stage of the raising of ZK 736900 R lever ass'y
6. ZK735000 B button ass'y		1) Operation of ZK735000 R button ass'y CE313500 Sprocket must not be disengaged when ZK735000 R button ass'y is depressed 0.86 mm from the level of ZK736800 Bottom plate ass'y, but must be disengaged without fail before ZK 735000 R button ass'y is depressed to the locking position. Also when depressed, ZK735000 R button ass'y must not go below the bottom surface of the hollow spot. 2) Restoration of ZK735000 R button ass'y ZK735000 R button ass'y must be restored by turning corresponding to one frame length. 3) ZK738600 R button ass'y operating strength 110 ± 20 g when ZK738600 R button ass'y has been depressed to the locking position.

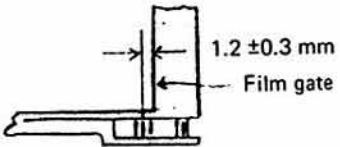
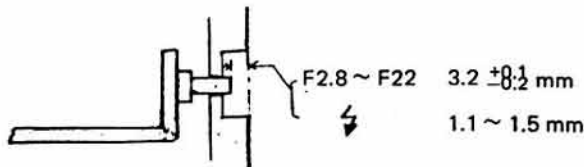
Components to be inspection	Related items	Inspection standards
7. ZJ138100 Rear cover ass'y		1) Opening and closing of ZJ138100 Rear cover ass'y ZJ138100 Rear cover ass'y must open and close without fail. 2) With ZJ138100 Rear cover ass'y opened, CE305000 M key must be locked without fail, thereby enabling smooth loading and unloading of a film cartridge.
8. CE313500 Sprocket		1) Allowable play of CE313500 Sprocket 0.12 mm max. in the vertical direction 0.9 mm max. on the root circle in the direction of turning 2) Tooth position 1.2 ±0.3 mm from the right end of the film gate to the tip of a tooth (Take up any amount of play of the tooth to the film cartridge side.)  3) Friction by the turning of CE313500 Sprocket when disengaged by depressing ZK735000 R button ass'y 30 ±10 g at the tooth root
9. CA752900 Spool AM		1) Allowable play of CA752900 Spool AM 0.45 ±0.25 mm in the vertical direction 0.5 mm max. on the circumference in the direction of turning 2) CA752900 Spool AM strength 170 ±30 x 6 g-mm
10. ZK737200 ZK739900 ZK740000 AS lever ass'y		1) Clearance between AS lever ass'y and the side of body 3.2 $\begin{smallmatrix} +0.1 \\ -0.2 \end{smallmatrix}$ mm when ZK739700 FN lever ass'y is in the range of F2.8 to F22 1.1 ~ 1.5 mm when ZK739700 FN lever ass'y is at Flash. 2) Restoring strength of AS lever ass'y 250 g max. 

28

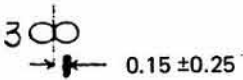
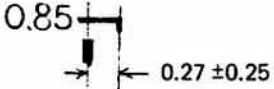
Components to be inspection	Related items	Inspection standards
11. CE302100 Self lever		Clicking strength of CE302100 Self lever 150 ± 50 g at the end of the lever
	(1) LED	1) Brightness of LED LED must be discernible at a distance of 3 m when turned on in the brightness of BV15 with the light source placed behind the camera. 2) Operation of LED LED must light up when the battery is checked and blink 20 ± 5 times for 10 seconds when the self-timer is in operation.
	(2) Beeper (piezo-electric element)	Operation of beeper The beeper must sound continuously when the battery is checked and intermittently 20 ± 5 times for 10 seconds when the self-timer is in operation.
(3) Operating condition for self-timer	The self-timer must not start functioning when the shutter release lock works on a voltage below the lock voltage.	
12. ZK739300 ZK739800 Focusing ring ass'y		1) Allowable focusing errors 0.15 ± 0.25 mm for $\frac{1}{2}$ setting  0.27 ± 0.25 mm for 0.85 m setting  2) Focusing ring turning strength $10 \sim 40$ g 3) Allowable play of the focusing ring 0.08 mm max. in the radial direction The focusing ring must be fixed so firmly that the end of the focusing lever will not move back and forth markedly

29

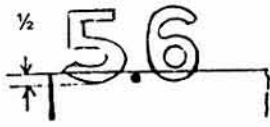
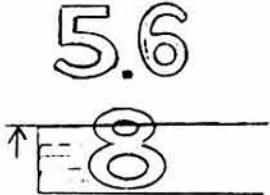
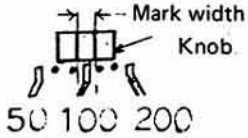
Components to be inspection	Related items	Inspection standards						
<p>13. ZK739700 FN lever ass'y</p>		<p>1) Allowable setting error The aperture selector knob is allowed to overlap a numeral of the specified f number. The overlapping, however, is limited to ½ the thickness of the numeral as illustrated below.</p>  <p>The lowest limit for the setting of the aperture selector knob at the said numeral is just below the highest horizontal stroke, as illustrated below, of a numeral immediately below the one of the specified f number.</p>  <p>2) Clicking strength</p> <table border="0"> <tr> <td>F2.8 ↔ F22</td> <td>200^{±50} g</td> </tr> <tr> <td>F2.8 → "Flash"</td> <td>400⁺⁸⁰₋₅₀ g</td> </tr> <tr> <td>"Flash" → F2.8</td> <td>170^{±50} g</td> </tr> </table> <p>3) Return of ZK739700 FN lever ass'y ZK739700 FN lever ass'y must return to F2.8 from when ZK737200, ZK739900, ZK740000 AS lever ass'y has been pushed 3 mm away from the side of the body.</p>	F2.8 ↔ F22	200 ^{±50} g	F2.8 → "Flash"	400 ⁺⁸⁰ ₋₅₀ g	"Flash" → F2.8	170 ^{±50} g
F2.8 ↔ F22	200 ^{±50} g							
F2.8 → "Flash"	400 ⁺⁸⁰ ₋₅₀ g							
"Flash" → F2.8	170 ^{±50} g							
<p>14. ZK739200 ASA ring ass'y</p>		<p>1) Setting of ASA number Any ASA number indicator must be set within the width of the mark on the ASA lever.</p>  <p>2) Clicking strength 300 ± 100 g</p>						

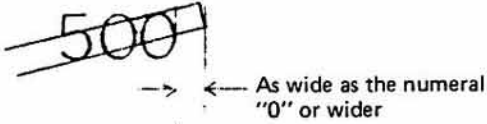
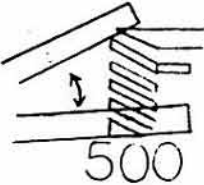
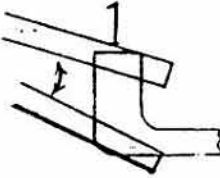
Components to be inspection	Related items	Inspection standards
15. Meter		<p>1) The indicator must not drift, cling nor stick.</p> <p>2) Length of the indicator The indicator must be long enough to extend beyond the right side of the numeral "500" as illustrated below.</p>  <p>3) Operation range of the indicator</p> <p>Improper exposure zone In case of combination of BV14, ASA100 and F2.8, the indicator must remain in the zone illustrated below.</p>  <p>Long-standing exposure display zone In case of combination of BV8, ASA100 and F2.8, the indicator must remain in the zone illustrated below.</p> 

II. PERFORMANCE

1. Accuracy of meter indication

LSBL7 Light source box K = 1.3 ASA100

BV	F No.	SS	Accuracy
15	8	1/500	+0.3 $\begin{smallmatrix} +0.6 \\ -0.7 \end{smallmatrix}$
12	8	1/60	+0.1 ± 0.6
9	8	1/8	0 ± 0.6
9	16	1/2	-0.2 $\begin{smallmatrix} +0.6 \\ -0.8 \end{smallmatrix}$

LSBL1 Light source box K - 1.3 ASA100

BV	F No.	SS	Accuracy
14	5.6	1/500	+0.3 $\begin{smallmatrix} +0.6 \\ -0.7 \end{smallmatrix}$
12	8	1/60	+0.1 ± 0.6
8	5.6	1/8	0 ± 0.6
8	11	1/2	-0.2 $\begin{smallmatrix} +0.6 \\ -0.8 \end{smallmatrix}$

Method of reading indicated values

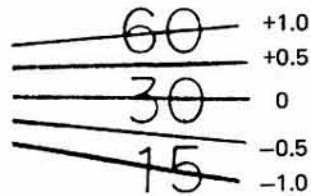

2. Accuracy of meter at the time of changing ASA numbers

BV	F No.	ASA	SS	Accuracy
14	22	50	1/8	0 ± 0.6
8	22	400	1/1	-0.2 $\begin{smallmatrix} +0.6 \\ -0.8 \end{smallmatrix}$
8	2.8	400	1/60	+0.1 ± 0.6

3. Accuracy of plus correction indication

BV11 F5.6 ASA100 +0.5 ± 0.5 step
At the other f numbers: 1.0 ~ 2.0 steps

4. EE accuracy K = 1.7 ASA100 B = 3.15 V

In case of K = 1.3,

BV	F No.	EE accuracy
14	5.6	+0.9 $\begin{smallmatrix} +1.0 \\ -0.75 \end{smallmatrix}$ EV (+0.15 ~ +1.9)
12	5.6	+0.4 ± 0.75 EV (-0.35 ~ +1.15)
10	5.6	+0.4 ± 0.75 EV (-0.35 ~ +1.15)
6	5.6	+0.15 $\begin{smallmatrix} +1.0 \\ -0.75 \end{smallmatrix}$ EV (-0.60 ~ +1.15)

5. EE accuracy at the time of changing ASA numbers

BV	F No.	ASA	EE accuracy
14	22	25	+0.4 ± 0.75 EV (-0.35 ~ +1.15)
8	2.8	400	+0.65 ± 0.75 EV (-0.10 ~ +1.4)
8	2.8	800	+0.65 ± 0.75 EV (-0.10 ~ +1.4)

6. EE accuracy at the time of plus correction

1.68 ± 0.4 EV

7. Longest exposure time

10 ~ 20 seconds in total darkness when ASA number is set at 100.

8. Shutter speed at the time of flashing

1/30 ~ 1/500 second with ZK739700 FN lever ass'y set at "Flash".

9. Shutter speed at the time of film loading

Faster than 1/8 seconds with CE300500 Front cover closed and ZJ138100 Rear cover left open.

32

10. Rangefinder accuracy

1/75 19.42 ±0.05

1 m 19.30 $\begin{matrix} +0.12 \\ -0.07 \end{matrix}$

Horizontal deviation: 1' max.

Vertical deviation: 1'30" max.

Collapse of double image:

Deviation at each end of the rangefinder must be a maximum of 1'30".

Magnification difference:

With the focusing ring set at ∞ , the deviation at each end of the rangefinder must be a maximum of 1'30".

Eyesight difference: 0 ±0.1

11. Power consumption

800 μ A max. with ASA800, F2.8 and BV15

12. Power consumption in the dark

10 μ A max. after the camera has been placed in the dark for 30 minutes.

13. X synchronization efficiency

60% min. (1 ms intervals) with ASA100 and f number at "Flash".

14. Insulation resistance



200 M Ω min. on 500 V

15. X synchronization time lag

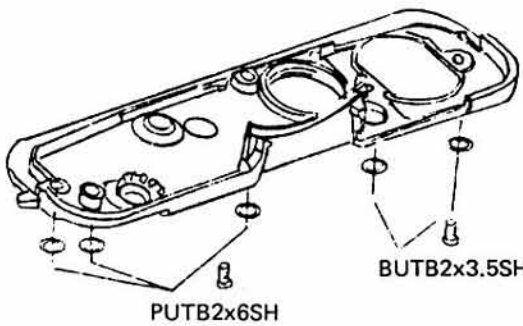
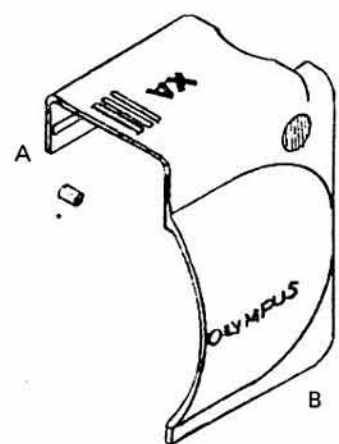

-0.35 ~ +1.0 ms with ASA100 and F2.8
(The shutter speed is at its maximum.)

C. ORDER OF DISASSEMBLY

REMOVAL OF SECTOR

Main parts	Parts to be removed	Q'ty	Parts which are to come off	Remarks
1. ZK738600 Bottom palte ass'y	PUTB2x3.5SH PUTB2x6SH	2 3	ZK738600 Bottom plate ass'y NW2.1-232PB, 5 pcs.	Screw the bottom plate assembly pressing the bottom plate against the rear cover and hinge in such a manner that the bottom plate assembly will be flush with the body. Care must be exercised so as not to damage the screw threads. See the repairing instructions below for replacement of the body and the bottom cover since a new model and an old one are available for each of them.
				
2. CE300500 Front cover			CE300500 Front cover CE309700 K roller	Put A and B in the groove in that order.
				
3. CE317700 R knob	PUK2-208SH (R screw)	1	CE317700 R knob ZK736900 R lever ass'y CA873000 Pin CE319100 R lever spring CE317100 R knob washer	
				

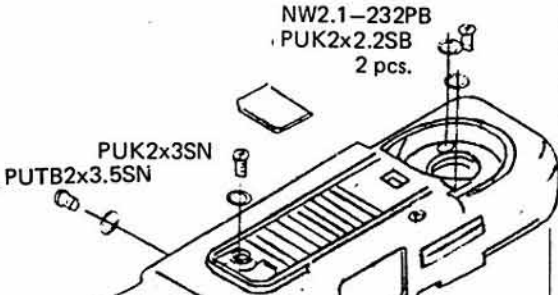
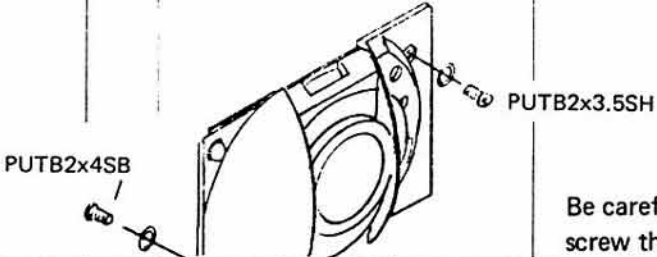

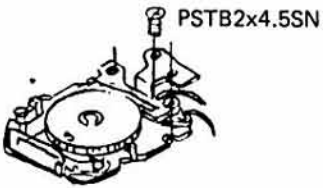
34

Main parts	Parts to be removed	Q'ty	Parts which are to come off	Remarks
4. ZK738500 Top cover ass'y	PUTB2x3.5SH PUK2x2.2SB PUK2x3SN	1 2 1	ZK738500 Top cover CE336800 Button Disconnect the lead wire of the buzzer by removing solder.	Put ZK738500 Top cover in place in such a manner that CE308500 Plate will fit in front of LC409800 Cover glass and screw it pressing the top cover against the rear cover and the hinge so as to make the top cover flush with the body. Care must be exercised not to damage the screw threads.
			 <p>NW2.1-232PB PUK2x2.2SB 2 pcs.</p> <p>PUK2x3SN PUTB2x3.5SN</p>	
5. ZK738400 Front plate ass'y	PUTB2x4SB PUTB2x3.5SN	1 1	ZK738400 Front plate ass'y NW2.1-232PB, 2 pcs. CE308500 Plate	
			 <p>PUTB2x4SB</p> <p>PUTB2x3.5SH</p>	Be careful not to damage the screw threads.
6. Release button		1	Disconnect the lead wires of CE315500 Button washer and CE337500 Button contact by removing solder.	
				
7. ZK738300 F.W. base	PUTB2x4SN PSTB2x4.5SN	2 1	ZK738300 F.W. base ass'y Disconnect the lead wire of CE316500 U switch.	
			 <p>PSTB2x4.5SN</p>	Be careful not to damage the screw threads.

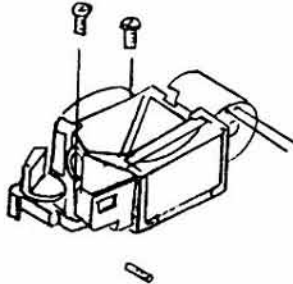
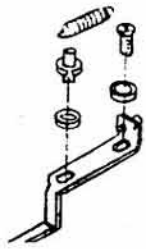
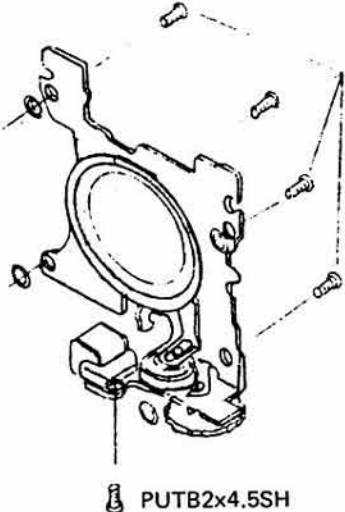
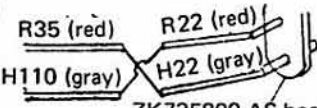
36

Main parts	Parts to be removed	Q'ty	Parts which are to come off	Remarks
8. Range finder	PUTB2x4.5SH	2	ZK738000 F. body ass'y CE332600 ~ 332900 Focusing pin 	
9. CE326100 AS lever	CA840400 CE325700	1 1	CE326100 AS spring CE326000 AS collar, 2 pcs. ZK737200 ZK739900 } AS lever ass'y ZK740000 } 	
10. Lens housing ass'y	PUTB2x4SN PUTB2x4.5SH	4 1	Lens housing ass'y 	<p> Pink, 2 pcs. } Yellow (28) } ZK736400 White (30) } Meter base Black (28) } ass'y Red (50) } Red (75) } Yellow(100) } ZK735500 Black (75) } Self base White (75) } plate ass'y Pink (75) } Orange (35) } ZK735800 Blue (110) } AS board } ass'y </p> <p> Connection of synchro lead wires for about 20,000 products to be manufactured during the initial stage of manufacture (March to May). Solder them in parallel with each other.  R35 (red) R22 (red) H110 (gray) H22 (gray) ZK735800 AS board ass'y </p>

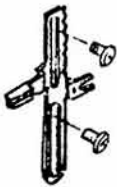
36

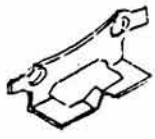
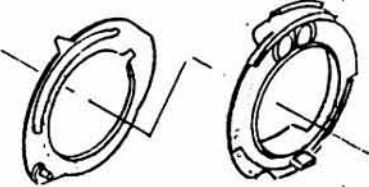
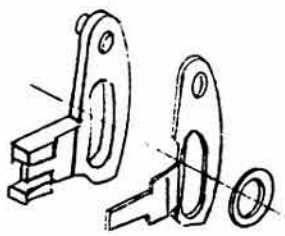
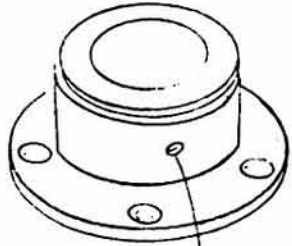
Main parts	Parts to be removed	Q'ty	Parts which are to come off	Remarks
11. ZK739700 FN lever ass'y	CE845700	2	ZK739700 FN lever ass'y 	
12. ZK737000 ASA plate ass'y	CE326600	1	ZK737000 ASA plate ass'y 	
13. CE322700 ASA click	PUK1.4x1.2SN	2	CE322700 ASA click 	
14. ZK739200 ASA ring ass'y	CdS (For green S) Lead wire	2	ZK739200 ASA ring ass'y ZK739100 FN plate ass'y 	
15. CE324100 Focusing lever	PUTB7x3.5SN	1	NW2.1-340PO CE324200 Float spring CE324100 Focusing lever 	(Caution) Prior to removing the focusing lever, make d7 clearance with d7 jib and fix the floating lens in place.  Fix the floating lens with HU1.4x1.5SN.

Main parts	Parts to be removed	Q'ty	Parts which are to come off	Remarks
16. CE319600 Front frame	PUK2x2.2SN PSK2x4SN	2 1	CE319600 Front frame ZK739300 Focusing ring M ass'y ZK739800 Focusing ring F ass'y CE319200 Diaphragm blade A CE319300 Diaphragm blade B	
17. Sector	PUK1.7x2.8SN	2	SC017800 Blade fastener SC017700 F spring SC017600 Shutter blade, 2 pcs. SC017500 Diaphragm fastener, 2 pcs.	

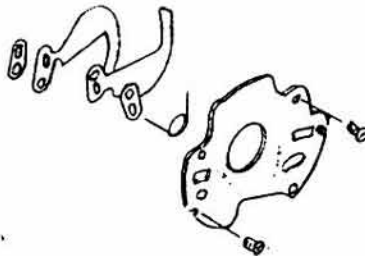
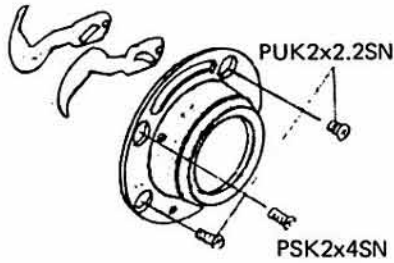

D. OUTLINE OF REPAIR



CONTENTS

I.	TROUBLE WITH FILM WINDING	
1.	Catching, rubbing and intermittent rubbing	D - 2
2.	Releasing of shutter immediately after film winding	D - 3
3.	Improper position of film perforations	3 - 3
4.	Movement of film at the time of releasing shutter	d - 4
5.	Difficulty in movement of exposure counter	d - 5
II.	TROUBLE WITH SHUTTER RELEASE AND RELATED PARTS	
1.	Shutter's failure to open when shutter release is pressed	D - 8
2.	Shutter's failure to open when shutter is pressed, though a click is produced	D-15
3.	Shutter's failure to return to its closed position	D-17
4.	Inaccurate EE functioning	D-18
5.	Defect due to which shutter can be released even when dust barrier is closed	D-18
6.	Shutter's failure to operate when rear cover is open	D-19
7.	Shutter's failure to operate at designed speed when aperture lever is set at "Flash" position	D-21
8.	Failure in synchronization	D-22
III.	TROUBLE WITH EXPOSURE METER	
1.	Indicator's failure to operate	D-23
2.	Inaccurate indication	D-24
IV.	TROUBLE WITH DIAPHRAGM SETTING	
1.	Failure of diaphragm blades to operate	D-25
2.	Inaccuracy of f number	D-25
V.	TROUBLE WITH LENS PERFORMANCE AND RANGE FINDER	
1.	Failure in focusing	D-26
2.	Lens focus adjustment	D-27
3.	How to determine the focal length	D-30
VI.	OTHER TROUBLE	
1.	Self-timer's failure to operate	D-31
2.	LED's failure to light up when mode selector lever is set at CHECK or SELF TIMER	D-32
3.	LED's failure to blink when mode selector lever is set at SELF TIMER	D-33
4.	Neon lamp's failure to pop up	D-34

39

I. TROUBLE WITH FILM WINDING

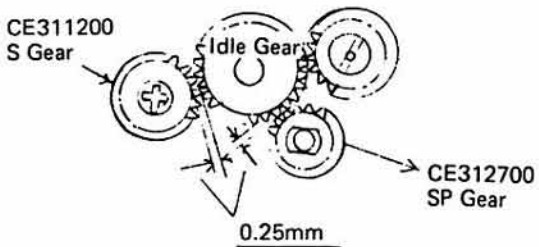
1. Catching, rubbing and intermittent rubbing

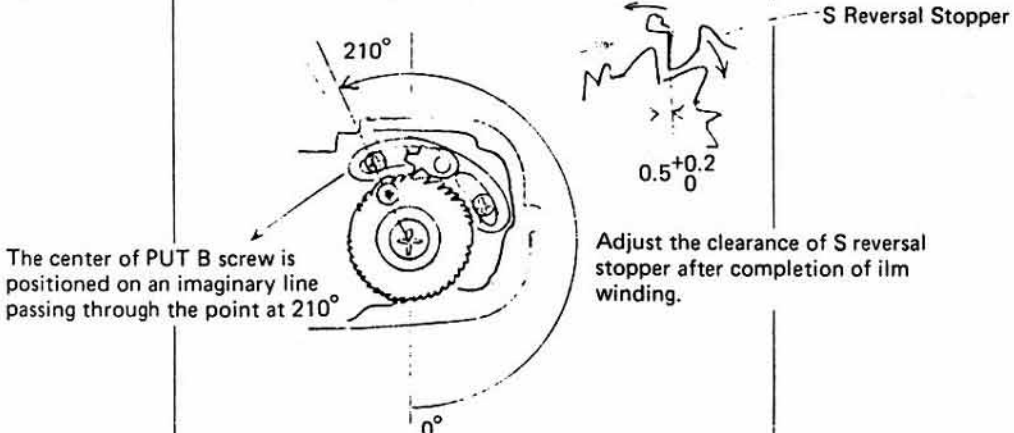
Cause	Remedial action	Remarks
1. Improper meshing of the teeth of CE-311200 S Gear with those of the idle gear	Improper meshing performed when ZK738900 Shutter Ass'y is integrated with ZK737600 Body Ass'y.	
2. Improper meshing of the teeth of CE-312700 SP Gear with those of the idle gear	Select an optimum CE312700 SP Gear to leave 0.25 mm clearance between CE312700 SP Gear and the idle gear. 	OD of CE312700 SP Gears CE312700 SP gear 1 8.22φ CE312800 SP gear 2 8.08φ CE312900 SP gear 3 7.94φ CE313000 SP gear 4 7.80φ CE313100 SP gear 5 7.66φ
3. Seizure of CE312700 SP Gear	Apply a small amount of Molycoat grease to CE313600 SP Washer. 	
4. Improper positioning of ZK735200 S Upper Plate Ass'y	Set S pin at an angle of $210 \pm 10^\circ$ by turning ZK735200 S Upper Plate Ass'y and attach ZK738900 Shutter Ass'y. 	S Reversal Stopper Adjust the clearance of S reversal stopper after completion of ilm winding.

2. Releasing of shutter immediately after film winding

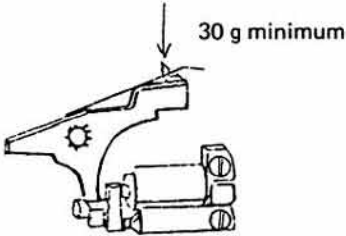
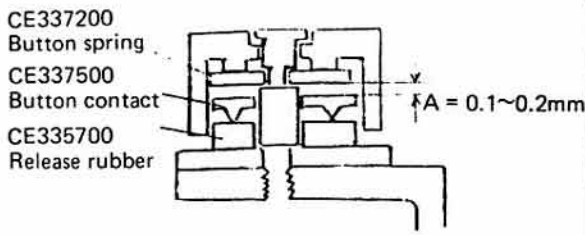
Cause	Remedial action	Remarks
<p>1. Lack of holding strength of SC0161 Magnet 1</p>	<p>Remove dirt or other extraneous matter from the receive and stop plates and check the holding strength. If it is less than 30 g, adjust or replace SC0161 Magnet 1 with a new one.</p> 	
<p>2. Failure to select an optimum button washer</p>	<p>Select an optimum button washer out of button washers 1 to 5 so that clearance A between CE-337200 Button Spring and CE337500 Button Contact will be in a range of 0.1 to 0.2 mm. (If there is no clearance between them, the shutter cannot be released.)</p> 	

3. Improper position of film perforations

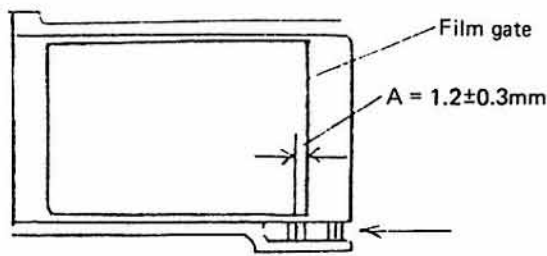
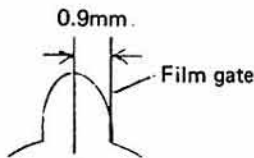
Cause	Remedial action	Remarks
<p>1. Improper position of CE313500 Sprocket</p>	<p>Adjust CE312700 SP Gear so that the teeth of CE313500 Sprocket will be placed at A after completion of film winding for one frame length.</p>  <p>Pushed in the direction indicated by an arrow.</p>	<p>0.9 mm when the flank of the root of a tooth of CE-313500 Sprocket is aligned with the film gate.</p>  <p>CE313500 Sprocket</p>

4. Movement of film at the time of releasing shutter

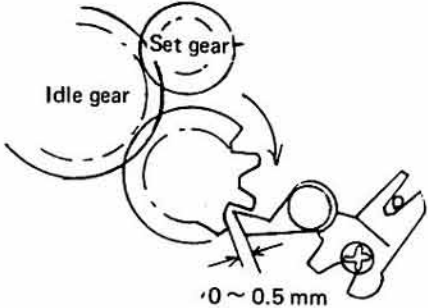
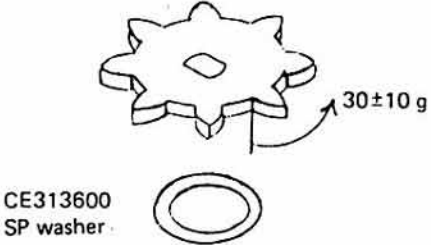
Cause	Remedial action	Remarks
<p>1. Improper adjustment of ZK737100 SP Claw Ass'y</p>	<p>After charging the shutter, make sure that a clearance of 0 ~ 0.05 mm is made between CE312700 SP Gear and ZK737100 SP Claw Ass'y when CE313500 Sprocket is turned in the direction indicated below, with the set gear held in place.</p> 	<p>Make sure by releasing the shutter 2 or 3 times that ZK737100 SP Claw Ass'y engages with CE312700 SP Gear.</p>
<p>2. Insufficient friction of CE383600 SP Washer</p>	<p>Remove CE313500 Sprocket and bend CE-313600 SP Washer further or replace it with a new one.</p> 	<p>When CE313500 Sprocket is turned without load, the friction measured at the root of a tooth must be 30 ± 10 g.</p>

74

42

5. Difficulty in movement of exposure counter

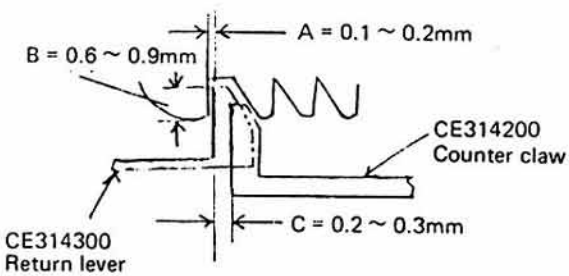
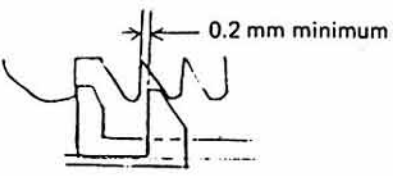
Cause	Remedial action	Remarks
<p>1. Improper adjustment of CE314300 Return Lever</p>	<p>Adjust the extent of engagement between CE-313800 Counter Gear and CE314300 Return Lever by bending the latter.</p> <ol style="list-style-type: none"> 1. As for the extent of engagement in the direction of thrust, CE314300 Return Lever must stay within the thickness of CE313800 Counter Gear. 2. Clearance A between CE314300 Return Lever and CE313800 Counter Gear must be in a range of 0.1 to 0.2 mm. 3. Distance B over which CE314300 Return Lever moves into CE313800 Counter Gear must be in a range of 0.6 to 0.9 mm. 4. Distance C must be in a range of 0.2 to 0.3 mm when CE314300 Return Lever is moved to the side of CE314300 Counter Claw and simultaneously CE314200 Counter Claw to the side of CE314300 Return Lever. 	
<p>2. Improper adjustment of CE314200 Counter Claw</p>	<p>Adjust the distance over which CE314200 Counter Claw moves to turn CE313800 Counter Gear.</p> <ol style="list-style-type: none"> 1. The clearance between CE314300 Return Lever and the flank of a tooth of CE313800 Counter Gear must be a minimum of 0.2 mm when CE314200 Counter Claw has completed moving CE313800 Counter Gear to the farthest possible point. 	<p style="text-align: right;">43</p>

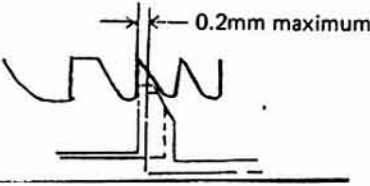
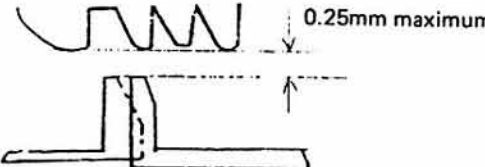
Cause	Remedial action	Remarks
	<p>2. When CE314200 Counter Claw has moved back to get in the following tooth space, the maximum clearance between CE314200 Counter Claw and the flank of the tooth of CE313800 Counter Gear must be a minimum of 0.2 mm.</p> 	
<p>3. Malfunctioning of CE314300 Return Lever</p>	<p>1. When CE314300 Return Lever is in contact with ZK737600 Body Ass'y and ZK738500 Top Cover Ass'y, bend CE314300 Return Lever out of contact.</p> <p>2. When CE314300 Return Lever fails to move back as far as designed and remains in contact with CE313800 Counter Gear, bend CE-314300 Return Lever out of contact. When ZJ138100 Rear Cover Ass'y is opened, clearance D must be 0.25 mm minimum.</p> 	

4A

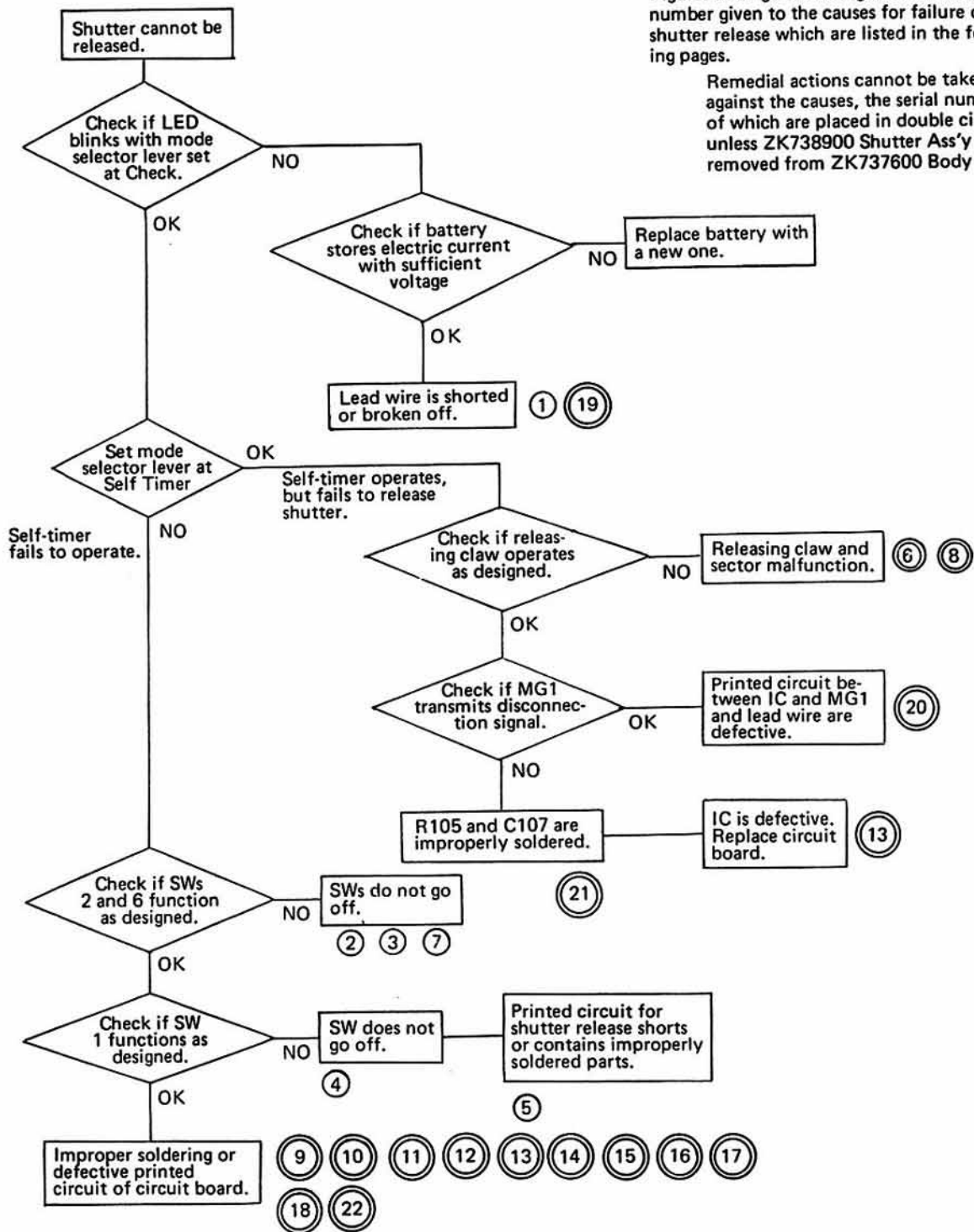

* Figures in single circles agree with the serial number given to the causes for failure of the shutter release which are listed in the following pages.



Remedial actions cannot be taken against the causes, the serial numbers of which are placed in double circles, unless ZK738900 Shutter Ass'y is removed from ZK737600 Body Ass'y.

II. TROUBLE WITH SHUTTER RELEASE AND RELATED PARTS

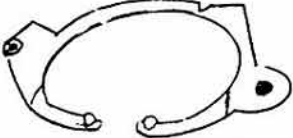
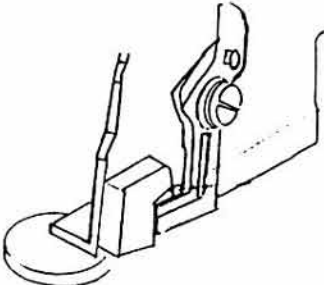
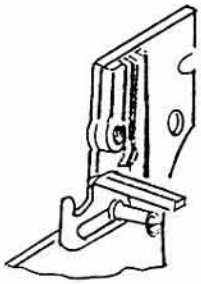
1. Shutter's failure to open when shutter release is pressed.

Cause	Remedial action	Remarks
<p>1. Improper contact of CE304700 B Contact 2</p>	<p>Improve resilience or correct deformation to increase contact pressure.</p> <div style="text-align: center;">  <p>CE304700 B Contact 2</p> </div>	
<p>2. Failure of SC0172 C Contact B to turn off (SW2)</p>	<p>1. Deformation or lack of resilience of SC0172 C Contact B causes SW2 to remain turned on. Correct the deformation or replace it.</p> <p>2. SC0169 malfunctions due to its burr being in contact with ZK738900 Shutter Ass'y.</p> <div style="text-align: center;">  <p>SC0172</p> <p>SC0169</p> </div>	<p>With completion of a film winding, SW-2 must always go off.</p> <p>Since the burr may be removed by releasing the shutter if the burr is in contact with ZK738900 Shutter Ass'y.</p>
<p>3. Failure of CE309000 K Switch to go off (SW-6)</p>	<p>1. Correct deformation of ZK739000 Lever Ass'y and make sure of its proper operation. (Arrange or repair the lead wire.)</p> <p>2. Deformation or lack of resilience of CE309000 K Switch causes SW-6 to remain turned on. Correct the deformation or replace it.</p> <div style="text-align: center;">  </div>	<p>ZK739000 Lever Ass'y must be interlocked with CE300500 Front Cover.</p>

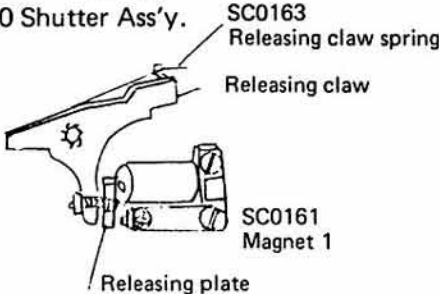
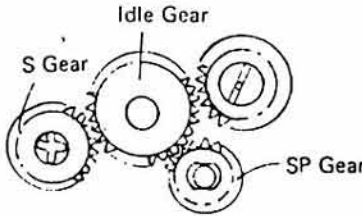
Cause	Remedial action	Remarks								
<p>4. Failure of release switch to go off.</p>	<p>1. When CE337200 Button Spring is deformed or lacks resilience, thereby coming in contact with CE335700 Release Contact, repair or replace as required.</p> <p>2. Wrong selection of a button washer Select the button washer which enables clearance A of 0.1 to 0.2 mm to be obtained between CE-337200 Button Spring and CE337500 Button Contact.</p> <div data-bbox="389 523 1059 880" data-label="Diagram"> <p>CE337200 Button Spring CE337500 Button contact CE335700 Release rubber</p> <p>Button washer 1 ~ 5</p> <p>CE315500 Button washer</p> <p>ZK738300 F.W. base ass'y</p> <p>CE337300 Button collar</p> <p>A = 0.1 ~ 0.2mm</p> <p>Clearance B must be maintained after the switch is turned on.</p> </div>	<p>The shutter must operate when the shutter release is pressed with a 0.1-mm-thick gauge (a piece of film) inserted in clearance A.</p> <p>Height C of button washer</p> <table border="1" data-bbox="1084 479 1398 739"> <thead> <tr> <th>Button washer</th> <th>Height C (mm)</th> </tr> </thead> <tbody> <tr> <td>CE336900 Button washer 1</td> <td>1.2</td> </tr> <tr> <td>CE337000 Button washer 2</td> <td>1.3</td> </tr> <tr> <td>CE337100 Button washer 3</td> <td>1.4</td> </tr> </tbody> </table>	Button washer	Height C (mm)	CE336900 Button washer 1	1.2	CE337000 Button washer 2	1.3	CE337100 Button washer 3	1.4
Button washer	Height C (mm)									
CE336900 Button washer 1	1.2									
CE337000 Button washer 2	1.3									
CE337100 Button washer 3	1.4									
<p>5. Improper soldering or shorting of the printed circuit for the shutter release</p>	<p>1. Check if the printed circuit of CE335100 Circuit Board and CE315500 Button Washer are properly soldered and, if not, resolder.</p> <p>2. Check CE337500 Button Contact and the lead wire and, if necessary, repair them.</p> <p>3. When a short circuit is established between the printed circuit of CE335100 Circuit Board and ZK738300 F.W. Base Ass'y, adhere an insulating tape to the printed circuit. Remove screws, PUTB2x4SN, from ZK738300 F.W. Base Ass'y and adhere an insulating tape around the circumference of the openings for the screws.</p> <div data-bbox="571 1508 1059 1653" data-label="Diagram"> <p>Remove these screws, PUTB2x4SN, and adhere the insulating tape.</p> </div> <p>* Do not re-tighten the screws. ZK738300 F.W. Base Ass'y can be fixed in place with 2 screws.</p>	<p>The number of the screws used to fix ZK738300 F.W. Base Ass'y was reduced from 3 to 2 from June, 1979.</p>								

Cause	Remedial action	Remarks
<p>6. Malfunctioning of releasing claw</p>	<ol style="list-style-type: none"> 1. SC016300 Releasing Claw Spring comes off. Check if it has sufficient strength and, if not, repair. 2. The releasing claw comes in contact with ZK738600 Bottom Plate Ass'y. Check and repair, if necessary. 3. The releasing plate is smeared with grease. Even if electric current flows to SC016100 Magnet 1, the releasing claw does not separate from SC0161 Magnet 1 due to grease on the releasing claw (or the releasing plate). Wipe grease off from the attracting surface of SC-0161 Magnet 1, releasing plate, releasing claw, tension spring, shutter lever and ZK-738900 Shutter Ass'y. 	<p>Make sure that SC0163 Releasing Claw Spring is not so strong as to cause the shutter only to click without opening when the shutter release is pressed.</p> <p>* Even if the releasing plate is smeared with grease, once the shutter is released, it continues to operate as designed. The shutter, however, refuses to operate again, if it is left untouched for a day or longer. The grease, therefore, must be wiped off without fail.</p>
<p>7. Extraneous matter between the teeth of gears</p>	<p>Check each gear. Make sure that the shutter refuses to operate, even if the releasing claw is pressed before completion of film winding. Remove the S gear or SP gear and turn the idle gear to see if the shutter can be charged.</p> 	
<p>8. Sticking of SC0176 Shutter Blade</p>	<ol style="list-style-type: none"> 1. If Bell Lock which was applied to the screws, PSK2x4SN, that fixes ZK739400 Lens Housing Ass'y in place, oozes out to SC0176 Shutter Shutter Blade, wipe it off. 2. If 023P Grease, that was applied to ZK73900 Lever Ass'y, oozes out to SC0176 Shutter Blade, wipe it off from ZK738900 Shutter Ass'y, CE319400 Sector Case and SC0176 Shutter Blade. 	<p>In case the shutter is not released when the releasing claw has moved to the side of SC0161 Magnet 1 by attraction, the sticking of SC0176 Shutter Blade is considered as its cause.</p> 

48

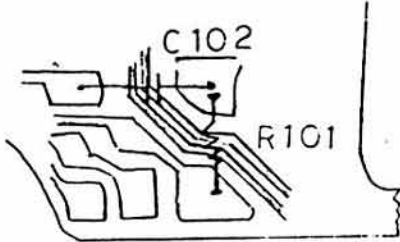
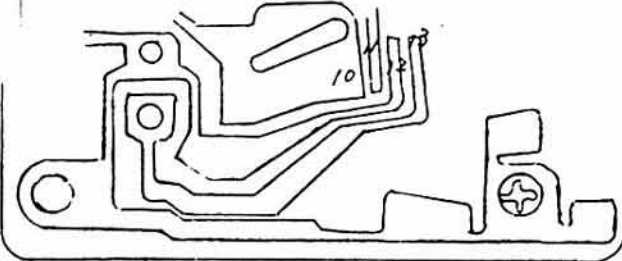
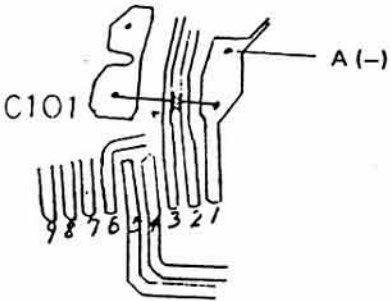
Cause	Remedial action	Remarks
<p>9. Short circuit between R101 and printed circuit</p>	<p>Check R101 and attach an insulating tape over the printed circuit.</p> 	
<p>10. Cracking of VR circuit board</p>	<p>Remove VR circuit board from ZK738900 Shutter Ass'y for inspection. If it is cracked, replace ZK738800 AMP. Board Ass'y.</p>	
<p>11. Damaged printed circuit of terminal No. 12 of IC</p>	<p>Check if the printed circuit of terminal No. 12 of IC is damaged. If so, reinforce it with a lead wire.</p> 	
<p>12. Damaged printed circuit of terminal No. 1 of IC</p>	<p>Check if the printed circuit of terminal No. 1 of IC is damaged. If so, reinforce it with a lead wire. (The foot of C101 is prone to break.)</p> 	
<p>13. Defective IC</p>	<p>Remove ZK738800 AMP. Board Ass'y from ZK-738900 Shutter Ass'y and check the former for any improper soldering and any defective printed circuit. If nothing is found wrong with it, check the circuit board for any malfunctioning. If it operates properly, consider the IC as defective and defective and replace ZK738800 AMP. Board Ass'y.</p>	<p style="text-align: right;">49</p>

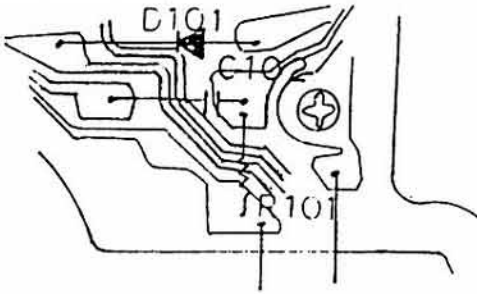
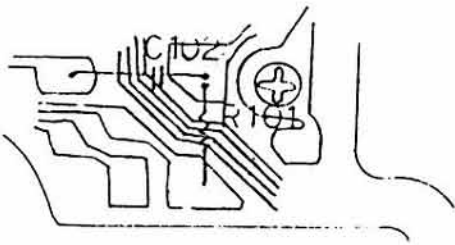
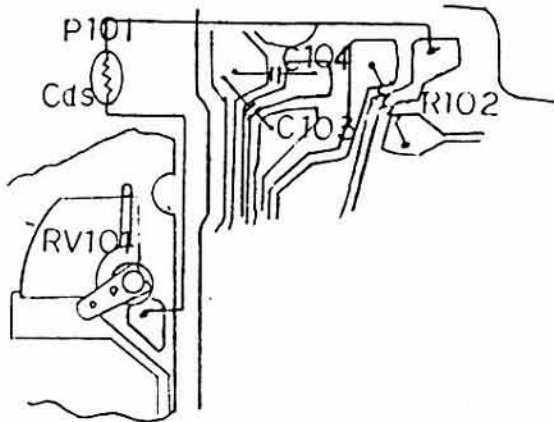
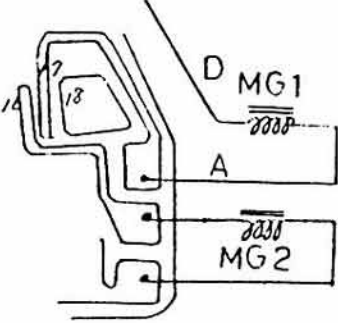
Cause	Remedial action	Remarks
14. Improperly soldered C102	Check C102 for any improper soldering and re-solder, if necessary. 	
15. Improperly soldered R101	Check if R101 is properly soldered and, if not, resolder. 	
16. Short-circuiting of CdS lead wire (green) to ZK738800 AMP. Board Ass'y (+)	Check CdS lead wire (green) and repair it, if necessary. 	
17. Short-circuiting of battery contact (-) to lead wire of SC-0161 Magnet 1	Check the lead wire and repair it, if necessary. 	

50.

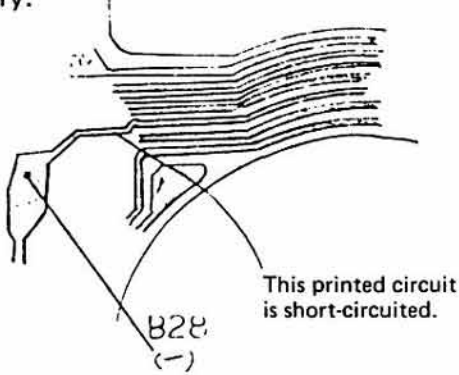
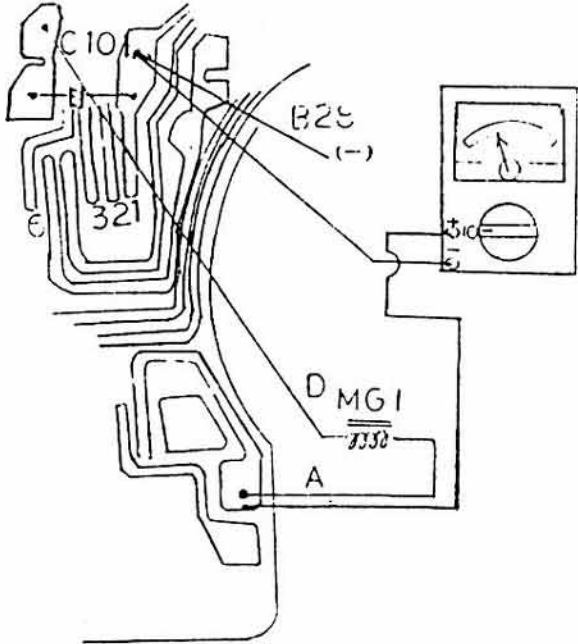
Cause	Remedial action	Remarks
<p>18. Short-circuiting of CE336300 Wire Stopper to printed circuit due to improper bending of the former.</p>	<p>Check CE336300 Wire Stopper and repair it, if necessary.</p> 	
<p>19. Short-circuiting of power source lead wire (-)</p>	<ol style="list-style-type: none"> 1. Short-circuiting of power source lead wire (B67). 2. Short-circuiting of ZK736400 Meter Base Ass'y to the connecting lead wire (B28) of ZK738800 AMP. Board Ass'y. 3. Short-circuiting of ZK738800 AMP. Board Ass'y to the connecting lead wire (B75) of ZK735500 Self Base Plate Ass'y. 	
<p>20. Disconnections in the coil of SC0161 Magnet 1, lead wire and printed circuit</p>	<p>Check if SC0161 Magnet 1 gives a disconnection signal. If it transmits the signal and the shutter is not released, check the coil of SC0161 Magnet 1, lead wire and printed circuit and repair them as required. (SC0161 Magnet 1 produces about 50Ω resistance.)</p> 	<p>Method of checking the connection signal. Use a DC 10V range of a voltmeter. When the negative terminal of the voltmeter is connected to the negative side of ZK738800 AMP. Board Ass'y and the positive terminal to the lead wire (blue) of SC0161 Magnet 1, the indicator of the voltmeter points at 3V. Simultaneous return of the indicator to the side of 0 volt with the turning on of SW-1 indicates transmission of the disconnection signal.</p>

5

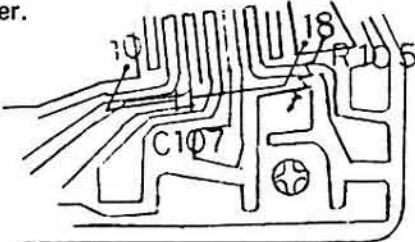
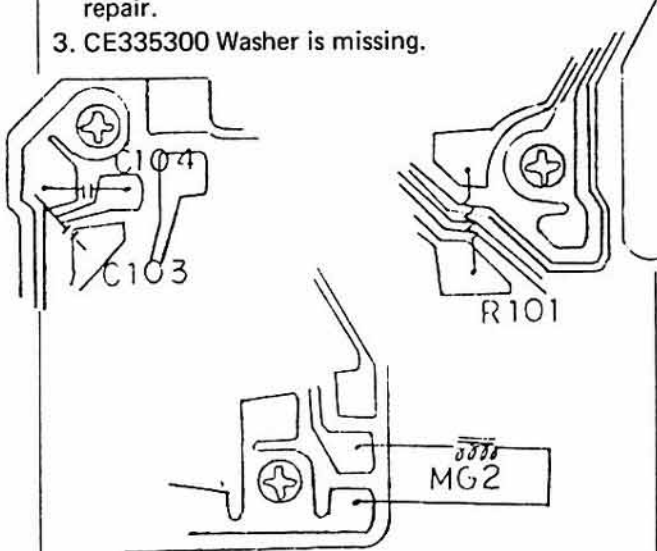
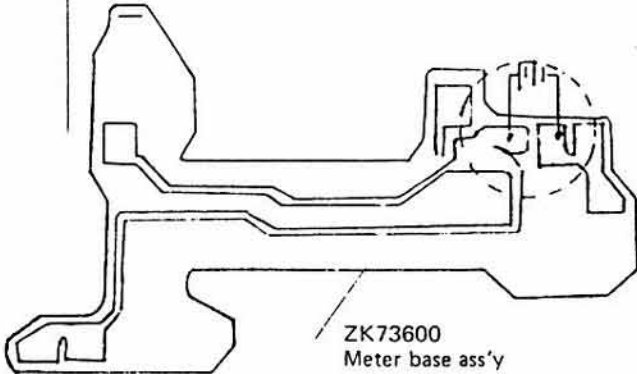
Cause	Remedial action	Remarks
<p>21. Improperly soldered R105</p>	<p>Even if the mode selector lever is set at Self Timer, the shutter is not released, though the beeper sounds. (The beeper does not stop sounding.)</p> <p>Check if R105 is properly soldered and, if not, resolder.</p> 	
<p>22. Loosely screwed ZK738800 AMP. Board Ass'y</p>	<ol style="list-style-type: none"> 1. Check if PUK1.4x2.5SN is tight and, if not, repair. 2. Check if PUK1.4x1.2SN is tight and, if not, repair. 3. CE335300 Washer is missing. 	
<p>23. Short-circuiting of the soldered part of ZK736400 Meter Base Ass'y</p>	<p>Check the soldered part of ZK736400 Meter Base Ass'y and repair it, if necessary.</p>  <p>ZK73600 Meter base ass'y</p>	

58

2. Shutter's failure to open when shutter release is pressed, though a click is produced.

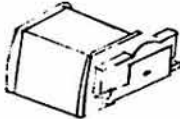
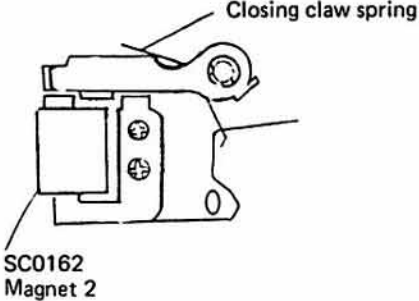
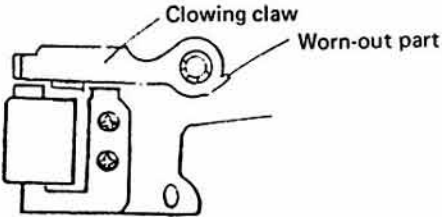
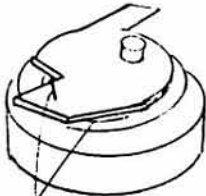
Cause	Remedial action	Remarks
<p>1. Contamination of SC0162 Magnet 1</p>	<p>Remove contaminants and extraneous matter from the attracting surface of SC0162 Magnet 1 and the closing claw.</p> 	
<p>2. Dislocation of closing claw spring</p>	<p>Put it back to where it should be.</p> 	
<p>3. Wear of closing calw</p>	<p>Replace the closing claw.</p> 	
<p>4. Maximum shutter speed being faster than designed</p>	<p>Check the maximum shutter speed. In case SC0180 Set Spring is so strong as to make the shutter speed faster than 3.25 ms, replace it with a new one.</p> 	<p>The maximum shutter speed must be in a range of 3.25 to 3.70 ms.</p>

53

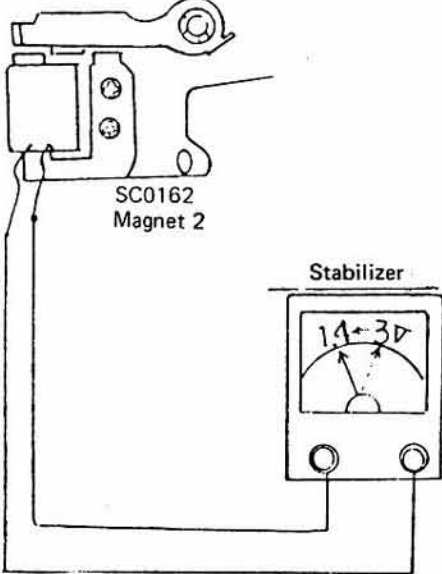
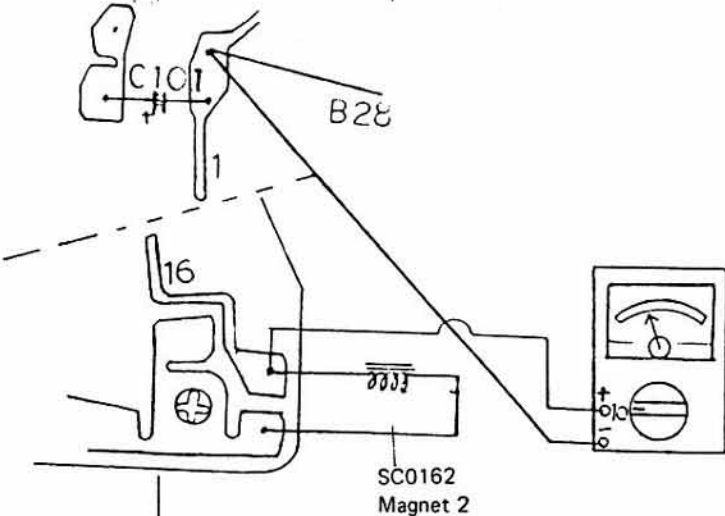
Cause	Remedial action	Remarks
<p>5. Insufficient holding strength of SC0162 Magnet 2</p>	<p>In case SC0162 Magnet 2 fails to hold the closing claw unless a voltage higher than 1.4V is applied to the former, it is considered defective. Connect SC0162 Magnet 2 to a stabilizer. Apply 3 volts to the magnet and reduce it to 1.4V. Release the shutter. If the shutter opens while the closing claw is held by the magnet, it is considered as functioning satisfactorily. Release the shutter repeatedly and if the shutter fails to open even once, while a click is produced, SC0162 Magnet 2 is considered defective.</p> 	<p>Check the attracting surface after cleaning.</p>
<p>6. Defective IC</p>	<p>Check the holding signal of SC0162 Magnet 2. If releasing the shutter fails to open it, but produces a click and the holding signal is not transmitted by the magnet, IC is considered defective.</p> 	<p>Method of checking the holding signal of SC0162 Magnet 2. Use a DC 10V range of a voltmeter. When the negative point of ZK738800 AMP. Board Ass'y and the positive terminal, to the negative lead wire of SC0162 Magnet 2, the indicator of the voltmeter points at 3V. Simultaneous return of the indicator to the side of 0 volt with the turning on of SW-1 indicates transmission of the holding signal.</p>

54

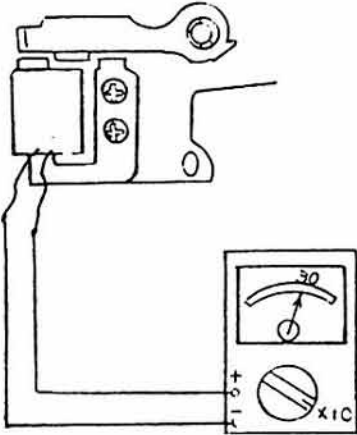
Cause	Remedial action	Remarks
7. Disconnection in SC0162 Magnet 2 or improperly soldered lead wire	<p>Check if SC0162 Magnet 2 conducts. Unless about 300Ω is detected, defect exists in the coil and the lead wire.</p> 	

3. Shutter's failure to return to its closed position

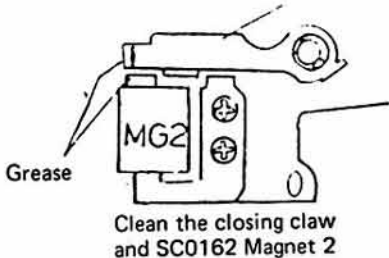
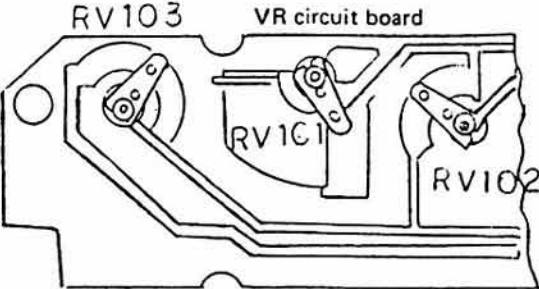
Cause	Remedial action	Remarks
1. Sticking of SC0162 Magnet 2	<p>In case the shutter fails to return to its closed position when power has been turned off, check SC0162 Magnet 2 and the closing claw and clean them, if necessary.</p> 	
2. Cracking of VR circuit board	<p>Check if VR circuit board is cracked. If so, replace ZK738800 AMP. Board Ass'y with a new one.</p> 	<p style="text-align: right;">55</p>

4. Inaccurate EE functioning

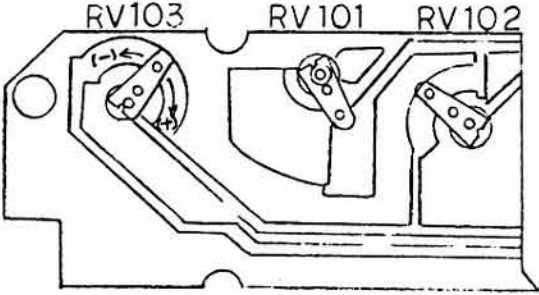
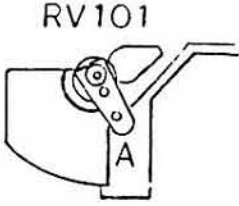
Cause	Remedial action	Remarks
<p>1. Improper adjustment of RV103</p>	<p>Check each of the specified check points with an EE tester and finely adjust RV103. If it is not adjustable, it indicates either CdS or the mechanism is out of order.</p> 	<p>K = 1.7</p>
<p>2. Improper position of RV contact of RV101</p>	<p>RV contact of RV101 must be positioned at A as given below. (RV101 is not loaded.)</p> 	

5. Defect due to which shutter can be released even when dust barrier is closed.

Cause	Remedial action	Remarks
<p>1. Failure of CE316500 U Switch to come on</p>	<p>1. Check CE314300 Return Lever. 2. Check if CE316500 U Switch is deformed or lacks resilience. 3. Check if the lead wires are properly soldered.</p> 	

56

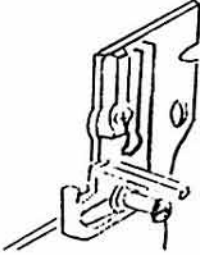
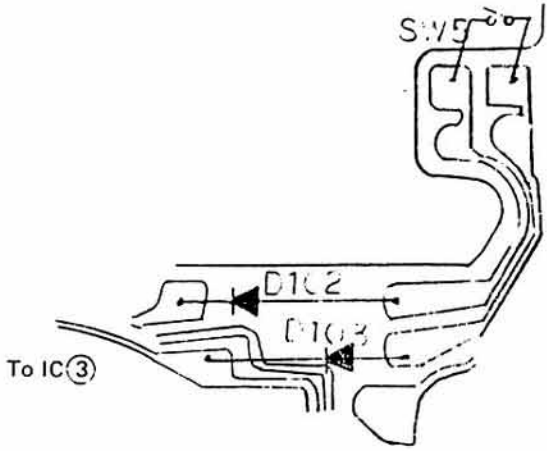
Cause	Remedial action	Remarks
<p>2. Failure of CE309000 K Switch to come on</p>	<p>1. Check if CE309000 K Switch is deformed or lacks resilience. 2. Check if the lead wire is properly soldered.</p> 	
<p>3. Disconnections in the printed circuit of ZK-738800 AMP. Board Ass'y</p>	<p>1. Repair the disconnections with lead wires or replace ZK738800 AMP. Board Ass'y. 2. Check if D101 is properly soldered and, if not, resolder.</p> 	

6. Shutter's failure to operate when rear cover is open.

Cause	Remedial action	Remarks
<p>1. Failure of CE316500 U Switch to go off (SW-5)</p>	<p>1. Check CE314300 Return Lever and repair, if necessary. 2. Check if the lead wires are properly soldered and, if not, resolder. 3. Check if CE316500 U Switch is deformed or lacks resilience.</p>  <p>CE316500 U switch</p>	<p style="text-align: right;">59</p>

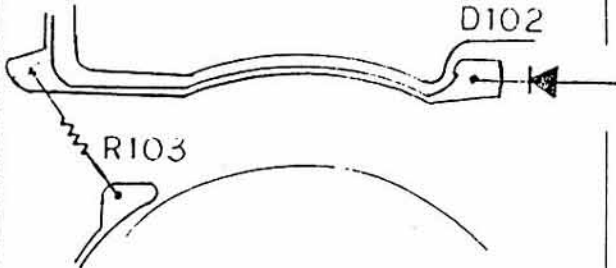
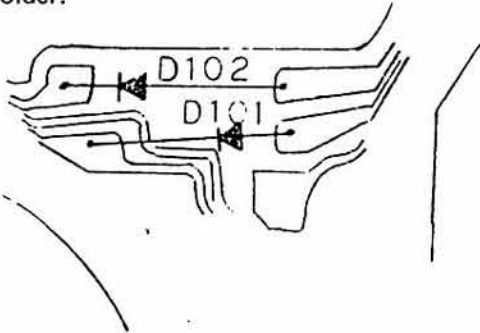
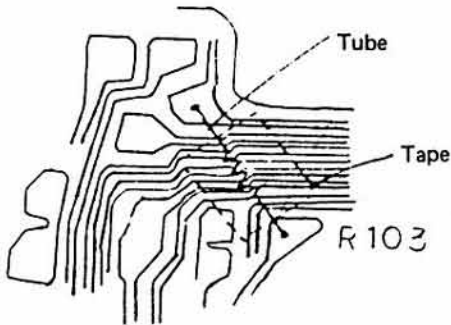
Cause	Remedial action	Remarks
2. Failure of CE309000 K Switch to come on (SW-6)	1. Check if CE309000 K Switch is deformed or lacks resilience and repair as required. 2. Check if the lead wires are properly soldered and, if not, resolder. <div data-bbox="617 321 920 574" style="text-align: center;">  <p>CE309000 K Switch</p> </div>	
3. Disconnection in the printed circuit between R103, and D102	Check the printed circuit. If it is broken, repair it with a lead wire. <div data-bbox="428 668 1044 936" style="text-align: center;">  </div>	
4. Improperly soldered D102	Check if D102 is properly soldered and, if not, resolder. <div data-bbox="480 1015 960 1348" style="text-align: center;">  </div>	
5. Broken leg or improper soldering of R103	1. Check R103 and repair, if necessary. 2. Short-circuiting of R103 to printed circuit. Insert the leg of R103 into a tube and attach a tape over the printed circuit. <div data-bbox="494 1544 945 1869" style="text-align: center;">  </div>	

58

Cause	Remedial action	Remarks
<p>6. Improper soldering or short-circuiting of R102</p>	<p>1. Check if R102 is properly soldered and, if not, resolder. 2. Short-circuiting of R102 to printed circuit.</p> 	

7. Shutter's failure to operate at the designed speed when aperture lever is set at "Flash" position.

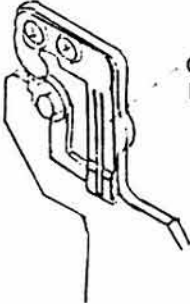
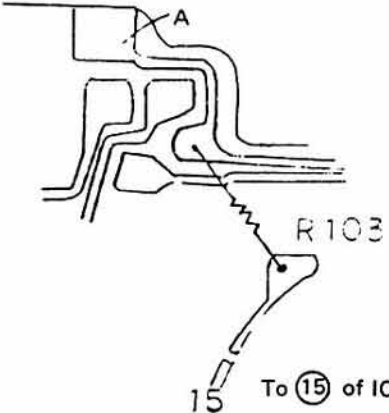
Cause	Remedial action	Remarks
<p>1. Improper contact made by CE335400 FS Contact (SW-7)</p>	<p>Check if CE335400 FS Contact is deformed or lacks resilience and repair it as required.</p> 	
<p>2. Disconnection in printed circuit</p>	<p>Check if the printed circuit is broken off and repair it, if necessary. (Printed circuit between section A at the perimeter of the circuit board and terminal No. 15 of IC.)</p> 	<p style="text-align: right;">59</p>

8. Failure in synchronization

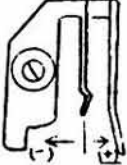
Cause	Remedial action	Remarks
1. Improper time lag 2. Poor conduction 3. Poor insulation	<p data-bbox="443 231 951 329">Check SC0164 x Contact A and SC0166 x Contact B for resilience, clearance and contamination. Also check their lead wires.</p> <div data-bbox="597 407 905 572"><p data-bbox="745 540 905 572">Adjust time lag.</p></div>	



60

III. TROUBLE WITH EXPOSURE METER

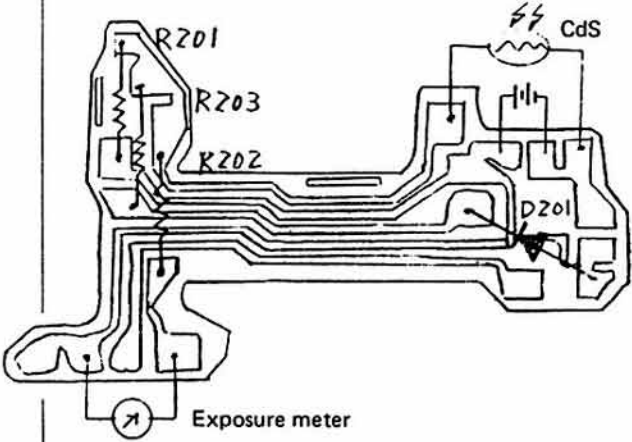
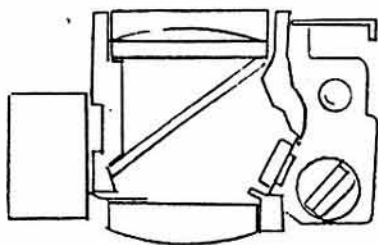
1. Indicator's failure to operate

Cause	Remedial action	Remarks
1. Improper contact of B contact	Check if ZK735600 B Contact 1 and AK736300 B Contact are deformed or lack resilience.	
2. Break and short-circuiting of lead wires	Check and repair, if necessary, the lead wires connected to the exposure meter.	
3. Defective ZK736400 Meter Base Ass'y	Check the printed circuit. 	
4. Defective moving parts	1. Check coils. 2. Check the indicator.	
5. Indicator in contact with ZK738000 F. Body Ass'y	Check the indicator. 	

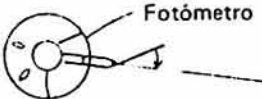
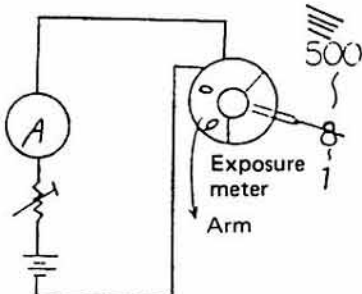
2. Inaccurate indication

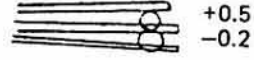
Cause	Remedial action	Remarks
1. Deformed indicator	Check the indicator. 	
2. Failure in matching	<p>1. 0 arm check Apply $77 \mu\text{A}$ current to the exposure meter and set the indicator at the shutter speed of $1/8$ by rotating the arm.</p>  <p>2. Adjustment of R202 and R201 Set ASA number at 100 and f number at 5.6 on the camera and adjust the resistance value of R201 so as to set the indicator at the shutter speed of $1/8$ when brightness is BV8. Also, when brightness is BV14, adjust the resistance value of R202 so as to set the indicator at the shutter speed of $1/500$.</p> <p>Standard resistance value $R201 = 12.4 \text{ K}\Omega$ (For high brightness adjustment) $R202 = \infty$ (For total adjustment)</p> <p>When the indicator is on the plus side as a whole, decrease the resistance value of R202 and when on the minus side as a whole, increase it.</p> <p>When the indicator cannot be set at the said shutter speeds by adjusting the resistance values of R202 and R201, perform the setting by rotating the arm.</p>	<p><u>ASA100 F5.6</u></p> <p>BV14  $+0.5$ -0.2</p> <p>BV11  $+0.7$ -0.5</p> <p>BV8  $+0.5$ -0.2</p> <p>Use the light source box which satisfies the equation of $K = 1.3$.</p>

62

IV. TROUBLE WITH DIAPHRAGM SETTING

1. Failure of diaphragm blades to function

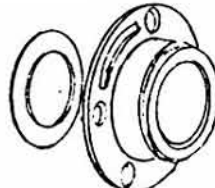
Cause	Remedial action	Remarks
1. No interlocking between CE323300 FN Plate and CE323500 FN Lever	Check the forked part of CE323500 FN Lever and the pin of CE323300 FN Plate. 	
2. CE319200 Diaphragm Blade A and CE319300 Diaphragm	1. Adjust CE320400 Oil Holder to be properly positioned. 2. Remove extraneous matter, if any, from CE-320400 Oil Holder. 	
3. Deformation and contamination with oil of CE319200 Diaphragm Blade B	1. Correct deformation or replace them. 2. If contaminated with oil or the like, clean them as well as CE320400 Oil Holder, CE-071800 Blade Fastener, etc. with Freon-TE.	

2. Inaccuracy of f number

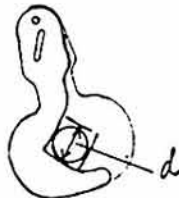
Cause	Remedial action	Remarks																
1. Improper adjustment of CE323800 FN Click	Check the f number with an f number tester and correct the setting positions. F number and aperture diameter  <table style="margin-left: auto; margin-right: auto;"> <thead> <tr> <th style="text-align: left;">F No.</th> <th style="text-align: left;">d</th> </tr> </thead> <tbody> <tr><td>2.8</td><td>7 ϕ</td></tr> <tr><td>4</td><td>5.2</td></tr> <tr><td>5.6</td><td>3.5</td></tr> <tr><td>8</td><td>2.6</td></tr> <tr><td>11</td><td>1.8</td></tr> <tr><td>16</td><td>1.3</td></tr> <tr><td>22</td><td>1</td></tr> </tbody> </table>	F No.	d	2.8	7 ϕ	4	5.2	5.6	3.5	8	2.6	11	1.8	16	1.3	22	1	Adjust the zero position on the f number tester. Attach jig No. 2 (aperture) to OM body + F1.8/50 mm. Set the f number at 5.6 on the tester to enable +1.06 to be displayed. F2.8 4 5.6 8 11 16 22 0±0.3EV 0±0.25EV <div style="text-align: right; font-size: 1.5em;">63</div>
F No.	d																	
2.8	7 ϕ																	
4	5.2																	
5.6	3.5																	
8	2.6																	
11	1.8																	
16	1.3																	
22	1																	

V. TROUBLE WITH LENS PERFORMANCE AND RANGE FINDER

1. Failure in focusing

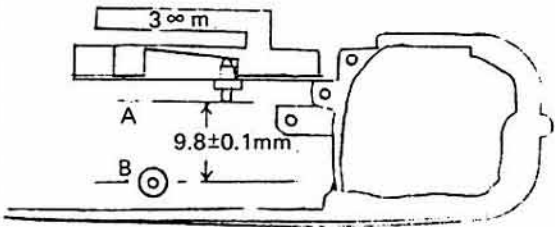
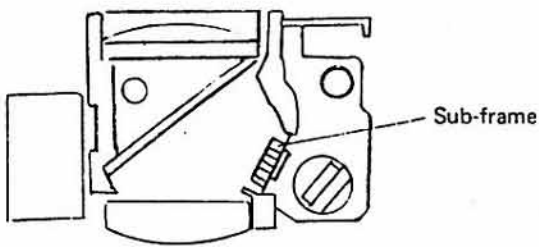
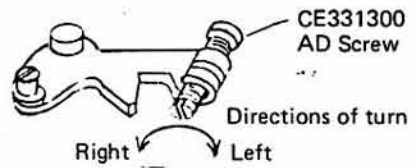
Cause	Remedial action	Remarks								
1. Improper focus adjustment	See "Adjustment procedure" on page 27.									
2. Improper interlocking of the range finder	<p>1. Select one out of CE332600 Focusing Pin 1 to CE332900 Focusing Pin 4.</p>  <p>When ZK739300 (ZK739800) Focusing Ring is set at ∞, clearance between the focusing pin (A) and the fixing hole of ZK738000 F Body Ass'y (B) must be 9.8 ± 0.1 mm.</p> <p>Lengths (mm) of focusing pins:</p> <table style="margin-left: 40px;"> <tr><td>CE332600</td><td>4.4</td></tr> <tr><td>CE332700</td><td>4.6</td></tr> <tr><td>CE332800</td><td>4.8</td></tr> <tr><td>CE332900</td><td>5.0</td></tr> </table> <p>2. Vertical unmatched Turn the sub-frame for adjustment.</p>  <p>3. Horizontal unmatched Turn CE331300 AD Screw for adjustment.</p> 	CE332600	4.4	CE332700	4.6	CE332800	4.8	CE332900	5.0	<p>Vertical unmatched at ∞ A maximum of 1'30" which corresponds to 1.5 graduations on the chart of the universal-type $f = 600$ mm collimator manufactured by Olympus.</p> <p>Horizontal unmatched at ∞ A maximum of 1' which corresponds to 1 graduation on the said chart.</p> <p>A reflected image moves to the right by turning CE-331300 AD Screw clockwise and vice versa.</p>
CE332600	4.4									
CE332700	4.6									
CE332800	4.8									
CE332900	5.0									

64

2. Lens focus adjustment

Do not replace lenses by element but by group.

Adjustment procedures:

1. Fix CE320300 Rear Lens Ass'y on ZK738900 Shutter Ass'y.

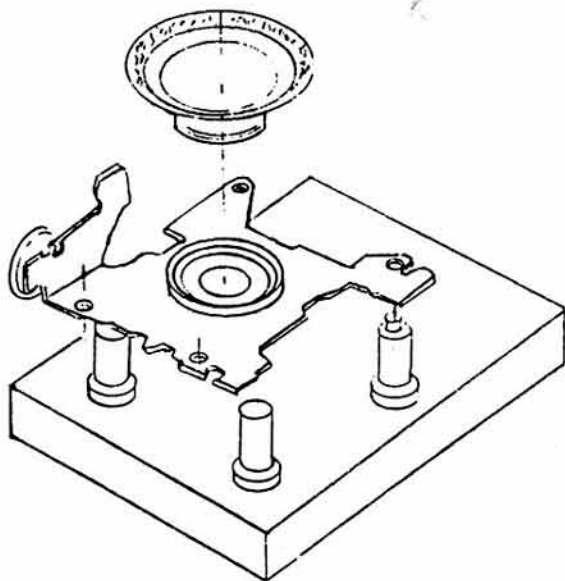

2. Open SC017600 Shutter Blade
Remove the reversal stopper and turn the idle gear about 5 mm counterclockwise. Let the releasing claw be attracted by SC0161 Magnet 1 and turn the idle gear clockwise.
3. Insert a d7 jig.
Insert KC0126 d7 Jig into CE319400 Sector Case of the shutter. (Care must be taken not to damage the lenses.)

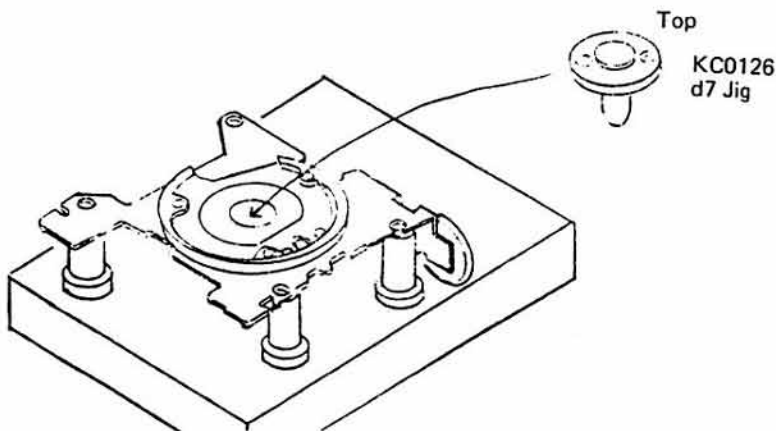

4. Set the floating lens of ZK739400 Lens Housing Ass'y at such a position that a subject can be focused at the shortest distance.

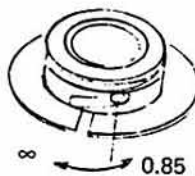

OD of float pin

CE310500	2.47φ
CE320600	2.48φ
CE310700	2.49φ
CE320800	2.50φ
CE320900	2.51φ

5. Screw ZK739400 Lens Housing Ass'y to ZK738900 Shutter Ass'y.
6. Move the floating lens gently in the direction of ∞ until it comes lightly in contact with KC0126 d7 Jig and fix the floating lens in place by tightening a screw, HU1.4x1.5SN.

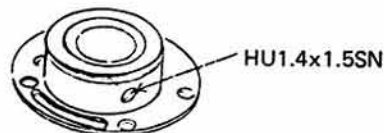

7. Remove ZK739400 Lens Housing Ass'y from ZK738900 Shutter Ass'y, take out KC0126 d7 Jig and check and clean the lens.
8. Put CE319200 Diaphragm Blade and CE319300 Diaphragm Blade in place in that order. (When the diaphragm blades are opened to the widest extent possible, they must not overlap the aperture.)

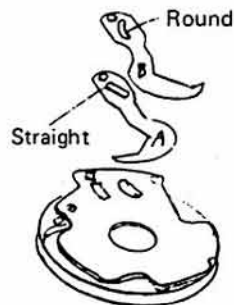

65

9. Screw ZK739400 Lens Housing Ass'y to ZK-738900 Shutter Ass'y. Put KCCE3196 Lens Housing Jig in place and check with a dial gauge if ZK738900 Shutter Ass'y is in parallel. Adhere a washer to ZK738900 Shutter Ass'y so as to keep the variation within 0.03. (Be sure to fix ZK739300 or ZK739800 Focusing Ring Ass'y in place prior to screwing ZK-739400 Lens Housing Ass'y.)

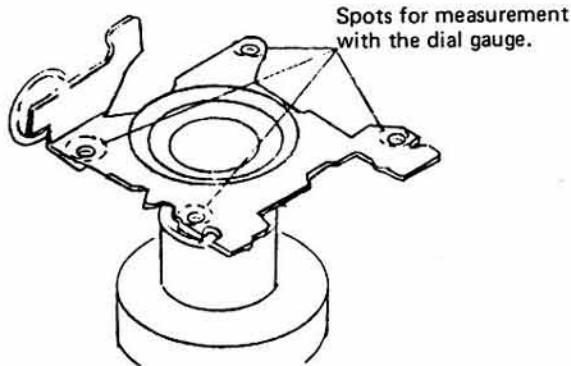

Thickness of NW

Thickness of NW

NW2.1-140PO	0.05 t
NW2.1-240PO	0.1 t
NW2.1-340PO	0.2 t
NW2.1-440PO	0.3 t
CE324600	0.4 t
CE324900	0.05 t

10. Screw ZK738900 Shutter Ass'y to ZK737600 Body Ass'y.
11. Put KCCE3196 Lens Housing Jig in place and check if ZK737600 Body Ass'y is in parallel. The variation of the heights of the top surfaces of the film pressure plate rails must be kept within 0.05. In case the variation is more than 0.05, remove ZK738900 Shutter Ass'y from ZK737600 Body Ass'y and replace the washer. (Do not adhere a washer to ZK737600 Body Ass'y; otherwise, the latter may be deformed by a solvent.)

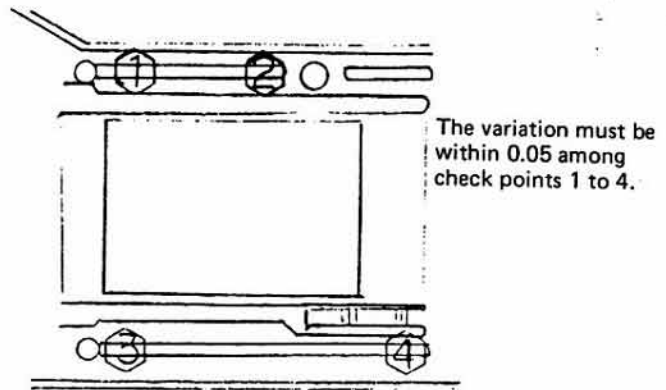

12. Read a focus deviation with the collimator.
 $1/75 = 0 \pm 0.05$

Collimator: 24LT-2DTS (Gokosha)

-14.4 +0.02 ± 0.05

Collimator: f = 300 fixed-on-object type
 (Pearl Optical Co., Ltd.)

-0.05 ± 0.05

13. Remove ZK738900 Shutter Ass'y from ZK-737600 Body Ass'y and adhere a washer to ZK738900 Shutter Ass'y to compensate for the focus deviation.
14. Screw ZK738900 Shutter Ass'y securely to ZK737600 Body Ass'y and make sure of no focus deviation.
15. Put ZK739300 (or ZK739800) Focusing Ring Ass'y in proper position with KCCE3240 Focusing Ring Gauge.
16. Fix CE324100 Focusing Lever and CE324200 Float Spring in place to interlock with CE-320500 Float Pins.

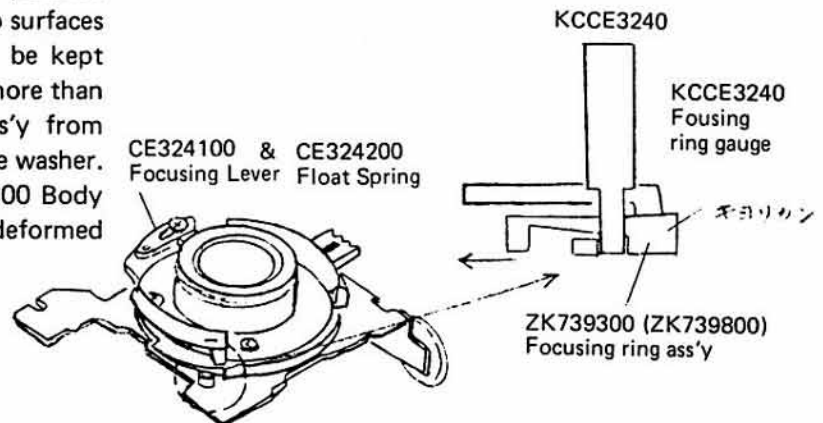

66

17. Remove screw, HU1.4x1.5SN, and check the operation of ZK739300 (or ZK739800) Focusing Ring Ass'y.

18. Check focus with a focusing ring 1/75 jig. If any deviation is detected, adjust focus by relocating ZK739300 (or ZK739800) Focusing Ring Ass'y and CE320500 Float Pins.

$$1/75 = 0 \pm 0.05$$

Collimator: 24LT-2DTS (Gokosha)

$$-14.4 +0.02 \pm 0.05$$

Collimator: f = 300 fixed-on-object type

(Pearl Optical Co., Ltd.)

$$-0.45 \pm 0.05$$

19. Check on focus and infinity.

$$\infty = 0 \begin{matrix} +0.05 \\ -0.04 \end{matrix}$$

Collimator: 24LT-2DTS (Gokosha)

$$+0.02 \begin{matrix} +0.05 \\ -0.04 \end{matrix}$$

Collimator: f = 300 fixed-on-object type

(Pearl Optical Co., Ltd.)

$$+0.02 \begin{matrix} +0.05 \\ -0.04 \end{matrix}$$

69

3. How to determine the focal length of XA

The focal length of XA is determined using collimators using collimators and jigs in the combinations shown in the table below. Care should be fully exercised in using KC0008 Stage, however, not to allow the sprocket of XA to move onto the jig.

Collimator \ Jig	KC0008 Stage		KC0120 Focus Point Base	
	2.67 m	∞	2.67 m	∞
Collimator, 24LT-2DTS, f = 193, manufactured by Gokosha	Use the collimator together with the jig after setting the objective of the former at -14.4. After turning the objective and reading the extent of the turn, the focal length is obtained by referring to Table 2 of the operating instructions issued by Gokosha. Standard: -11.95 ~ -15.45	Use the collimator together with the jig after setting the objective of the former at ∞ (0). Standard: +2.45 ~ -0.7	Set the objective of the collimator at -14.4 and directly read the focal length by turning the graduated ring of KC0120 Focus Point Base. Standard: +0.02 \pm 0.05	Set the objective of the collimator at ∞ (0) and directly read the focal length by turning the graduated ring of KC0120 Focus Point Base. Standard: +0.02 \pm 0.05 -0.04
Collimator, 32LT-2DTS, f = 300, manufactured by Gokosha	X	Use the collimator together with the jig after setting the objective of the former at ∞ (0). *The same method as in case of 24LT-2DTS used with KC0008 Stage. Standard: +5.25 ~ -1.5	Set the objective of the collimator at ∞ (0) and directly read the focal length by turning the graduated ring of KC0120 Focus Point Base. Standard: -0.45 \pm 0.05	Same as above.
Partical out of Focal Length Test Collimator, f = 300, movable type, manufactured by Pearl Optical Co., Ltd.	X	X	Same as above.	Same as above.
Partical out of Focus and Focal Length Test Collimator, f = 300, fixed type, manufactured by Pearl Optical Co., Ltd.	X	X	Same as above.	Same as above.

NOTE: Read the following operation manual for operation of the Partial out of Focus and Focal Length Test Collimators tabled above.
 Operation Manual for Partial out of Focus and Focal Length Test Collimator.

IV. OTHER TROUBLE

1. Self-timer failure to operate

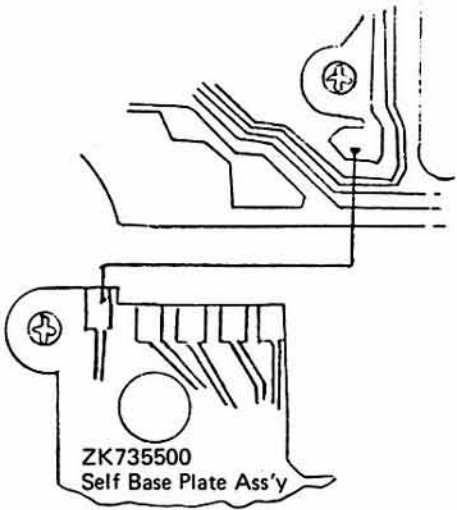
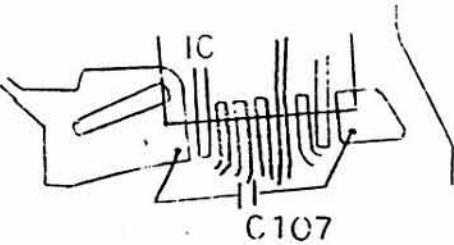
Cause	Remedial action	Remarks
<p>1. Improper soldering of ZK735500 Self Base Plate Ass'y and lead wire (red)</p>	<p>Check if lead wire R75 is properly soldered and, if not, resolder.</p> 	
<p>2. Malfunctioning and improper soldering of C107</p>	<p>1. Check with a circuit tester if C107 conducts and, if not, C107 is considered defective. 2. Check if C107 is properly soldered and, if not, resolder.</p> 	
<p>3. Defective IC</p>	<p>In case automatic devices other than the self-timer function properly and nothing is detected wrong with R105, C107 and lead wire R75, it is the IC that malfunctions.</p>	

69

2. LED's failure to light up when mode selector lever is set at Check or Self Timer

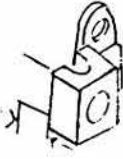
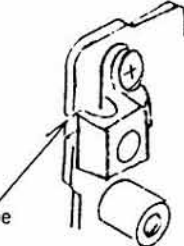
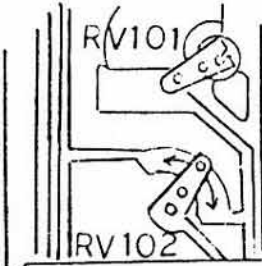
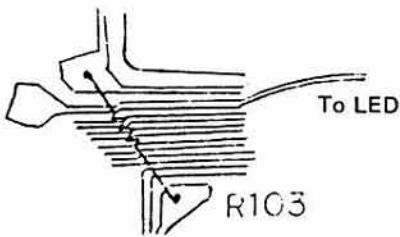
Cause	Remedial action	Remarks
<p>1. Defective LED</p>	<p>Check if LED conducts. If not, replace it.</p>  <p>A = 2.5 mm minimum</p> <p>Since LED is vulnerable to heat, the legs must be 2.5 mm minimum in length. When soldering it, do so within 4 seconds.</p>	<p>* When removing LED, care must be exercised not to change the diameter of the aperture by removal of the aperture lever which occurs with removal of LED. (Check the accuracy of f number.)</p>
<p>2. Short-circuiting of LED to ZK738900 Shutter Ass'y</p>	<p>Check LED's legs and attach an insulating tape to ZK739800 Shutter Ass'y.</p>  <p>Insulating tape</p>	
<p>3. Insufficient battery voltage</p>	<p>Check LED's turn-on voltage and adjust it, if insufficient.</p>  <p>Adjust the turn-on voltage by manipulating RV102.</p>	<p>LED's turn-on voltage = 2.2 ± 0.05 V</p>
<p>4. Short-circuiting of R103 to printed circuit</p>	<p>Check the printed circuit and repair, if necessary. Attach an insulating tape over the printed circuit.</p>  <p>To LED</p> <p>R103</p>	

70

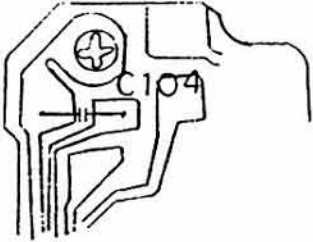
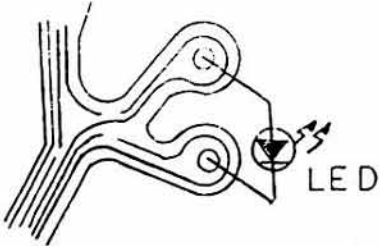
Cause	Remedial action	Remarks
5. Improper soldering of C104	Check if C104 is properly soldered and, if not, resolder. 	
6. Disconnection in printed circuit (at the soldered part of LED)	Check the printed circuit and repair, if necessary. 	

3. LED's failure to blink when mode selector lever is set at Self Timer

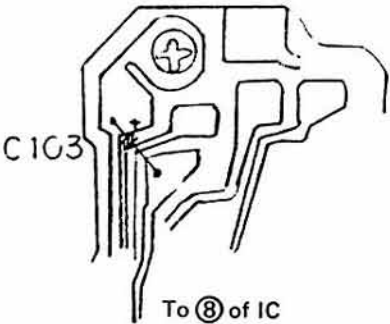
Cause	Remedial action	Remarks
1. Improperly soldered C103 or disconnection in printed circuit	1. Check if C103 is properly soldered and, if not, resolder. 2. Check the printed circuit on the side of C103 (-) and repair, if necessary. 	<div style="text-align: right;">71</div>

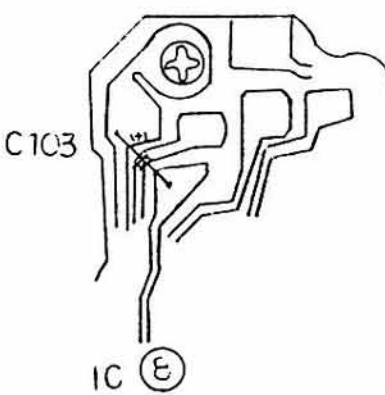

Cause	Remedial action	Remarks
2. Chort-circuiting of CdS lead wire (green) to ⑧ of IC	Check CdS lead wire (green) and repair, if necessary. 	

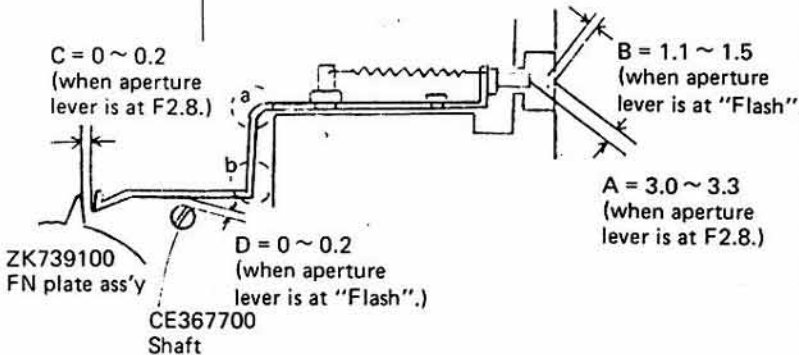
4. Neon lamp's failure to pop up

Cause	Remedial action	Remarks
1. Improper adjustment of ZK737200 AS Lever Ass'y	1. Select an optimum ZK737200 AS Lever Ass'y for clearance A. 2. Check and adjust clearances B to D as required.  <p> $C = 0 \sim 0.2$ (when aperture lever is at F2.8.) $D = 0 \sim 0.2$ (when aperture lever is at "Flash".) $B = 1.1 \sim 1.5$ (when aperture lever is at "Flash".) $A = 3.0 \sim 3.3$ (when aperture lever is at F2.8.) </p> <p> Clearance A can be obtained only by using an optimum ZK737200 AS Lever Ass'y. Clearances B to D can be obtained by adjusting bends at "a" and "b". </p>	Length of ZK737200 AS Lever Ass'y 1 = 3.45 mm ZK739900 AS Lever Ass'y 2 = 3.65 mm ZK740000 AS Lever Ass'y 3 = 3.85 mm

72

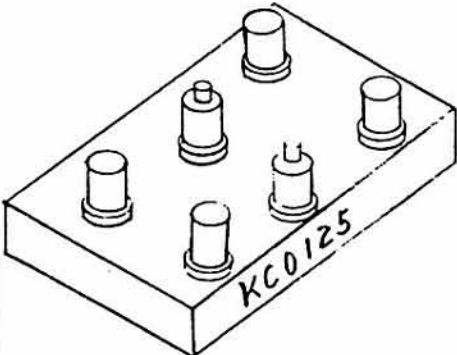
F. SPECIAL TOOLS

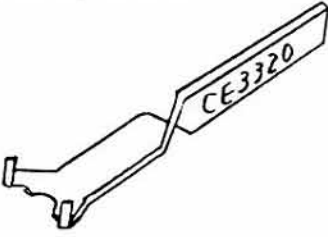
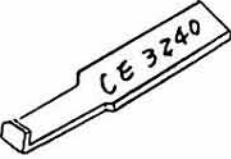
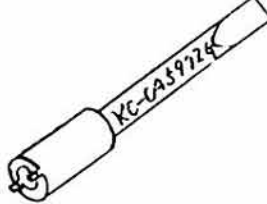
Name	Place used & usage	Remarks
<p>KC0125 Shutter holder</p> 	<p>This tool is designed to support ZK738900 Shutter ass'y. (See OUTLINE OF REPAIRS on page D-15.)</p>	
<p>KC0126 d7 jig</p> 	<p>d7 measuring gauge for the positioning of the floating lens.</p>	<p>The gauge is manufactured to the accuracy of 5.63 ± 0.002 mm. Handle it carefully and do not rust it.</p>
<p>KCCE3320 Wrench</p> 	<p>This tool is designed to adjust the range finder.</p>	
<p>KCCE3240 Focusing ring gauge</p> 	<p>Jig for the positioning of the focusing ring.</p>	
<p>KCCA5972G Driver</p> 	<p>Tool for removal of AS lever ass'y.</p>	<p>This tool is used with HLF-2T.</p>

73

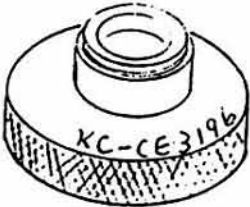
Name	Place used & usage	Remarks
<p data-bbox="170 178 505 211">KCCE3196 Lens housing jig</p> 	<p data-bbox="659 178 1028 315">This tool is designed to check parallelism for ZK739400 Lens housing ass'y. (See OUTLINE OF REPAIRS on page D-16.)</p>	

74

H. OTHERS

LEE-22 WIRING DIAGRAM

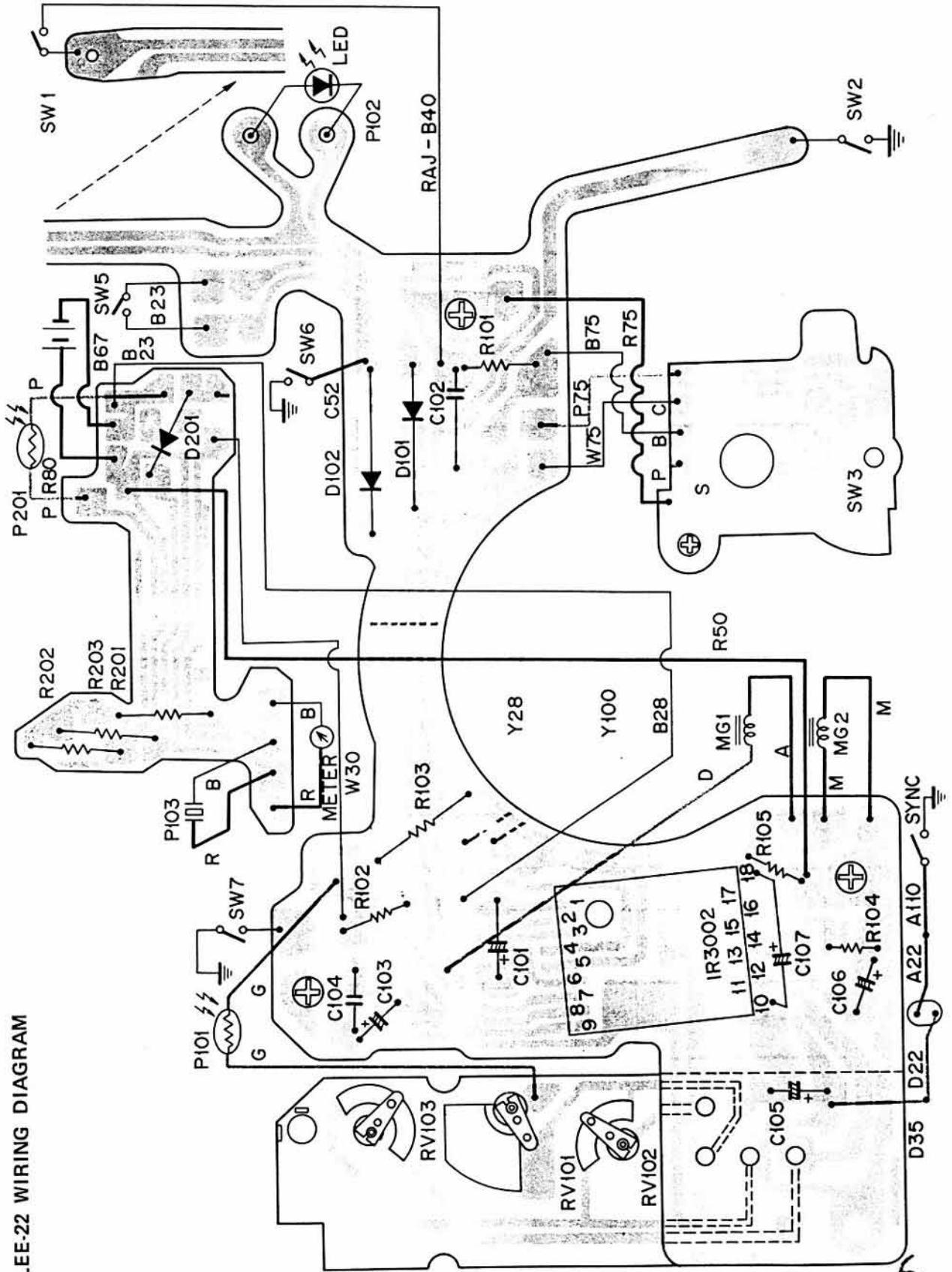

LEE-22 CIRCUIT DIAGRAM

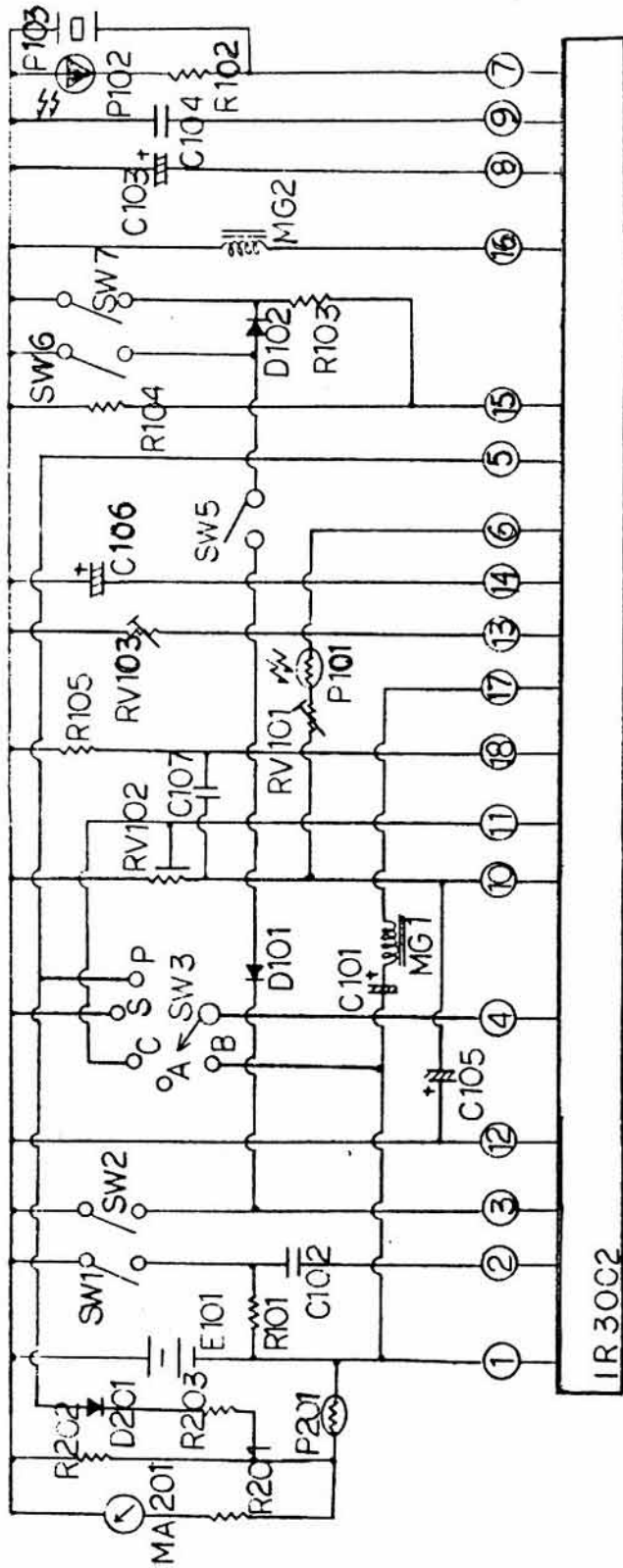

C101	KS0045	IR3002	ES2005	R101	RS0131	RV101	CE3352	25K
C102	KS0046	P101	ES5011	R102	RS0132	RV102	CE3352	53K
C103	KS0047	P102	ES5012	R103	RS0174	RV103	CE3352	100K
C104	KS0048	P103	CE3364	R104	RS0175			
C105	KS0052	P201	ES5013	R105	RS0130	D101	ES1002	
C106	KS0053	MA201	DS4002	R201	RS0135 ~	D102	ES1002	
C107	KS0054			R202	RS0142 ~	D201	ES1002	
				R203	RS0164 ~			
					RS0179			
					10.2K ~ 15.4K			
					4.3K ~ 220K			
					6.8K ~ 18K			
					4.7MΩ			
					300Ω			
					510Ω			
					2.4MΩ			
					820K			